

5.1 INTRODUCTION

Control Measures are any methods used to prevent or reduce the discharge of pollutants to State Waters¹. Implementation of control measures for erosion and sediment control, and stormwater treatment is a requirement of the Colorado Department of Public Safety's stormwater regulations.

Control measures should meet the following requirements

- The control measures must be designed using Good Engineering, Hydrologic and Pollution Control Practices.
- The control measures must be maintained in effective operating conditions.
- The control measures must be adequate for the permitted construction site.
- The control measures require routine maintenance to prevent potential failure.
- The control measures must minimize pollutant release outside of the permitted project area.

5.2 PLANNING

Required in all permitted construction activities from initial disturbance to final stabilization.

5.2.1 Site Assessment

Different factors should be assessed prior to the start of construction activities for every permitted CDOT construction site including:

- **Topography:** This is the primary factor to be considered in determining the control measures to be used at the site. Soils, vegetation, and hydrologic features must also be taken into account.
- **Grading:** This will determine the slope gradient and slope length. After grading is completed, areas that remain exposed to precipitation and runoff will require the inclusion of additional control measures. The appropriate control measures will be a function of the duration of exposure and whether grading is interim or final.
- **Soil conditions:** Identifying these will allow to determine erosion potential and suitability for revegetation. A detailed analysis of soil-erosion potential is not necessary because all soils will be subject to erosion and can be generalized as equivalent for the design of control measures. This analysis is also useful to determine fertilizer requirements for vegetation establishment.
- **Existing Vegetation:** As most vegetation will be removed from a construction site during clearing and grading operations, an assessment of existing onsite vegetation is of limited use when post-development landscaping and irrigation are planned but can be useful in selecting grasses when non-irrigated revegetation is intended. **Streams and other hydrologic features:** These are important in the design of control measures. The drainage basins upslope and within the site should be assessed, the configuration of hillslope areas and drainageways, in the context of planned roads and buildings, will determine the necessary erosion and sediment controls. The

location of permanent drainage channels and other elements of the drainage system should be defined as part of the plan.

5.2.2 Avoidance and Minimization

Vegetation is the most effective way to control erosion. During construction activities, soil disturbance typically removes this natural protective measure, exposes soils and increases their erosion potential. Avoiding disturbance is the optimal measure to control erosion and sedimentation; clearing and grubbing should only be conducted in portions of the site that are necessary for construction, preserving most of the existing vegetation elsewhere. Trees, bushes, and strips of natural vegetation in the area of construction should be preserved, as these natural elements will help hold soil particles in place, absorb the impact of rainfall, encourage infiltration, and slow the velocity of runoff. All feasible measures to avoid or minimize soil disturbances should be incorporated as early as the design phase of the project. Avoidance and minimization reduce the need for structural control measures. Examples of avoidance and minimization measures include:

- Providing a clear span bridge over a receiving water.
- Installing retaining walls adjacent to sensitive areas to avoid impact.
- Providing designated entries and exits as part of work access plan to the extent of land disturbance.
- Diverting offsite runoff away from construction areas.
- Defining areas of existing vegetation for protection on the plans.
- Designing roadway alignments to minimize impacts to sensitive areas.
- Prohibit staging and stockpiling material in wetlands and threaten and endangered habitats.

5.2.3 Scheduling and Phasing

Scheduling and Phasing involve developing a construction schedule and phasing plan that minimizes the amount of erosion created by the development. Limiting the amount of soil exposed at any given period of time, will result in the least impact to the area. The construction schedule must take into consideration the seasons and periods of heaviest precipitation, it should consider the available planting season to avoid having significant amount of exposed areas prior to the winter season (planting opportunities are limited during winter seasons).

Project phasing is encouraged in all CDOT projects; CDOT Standard Specifications limit disturbed areas to maximum area of temporary stabilization (excluding areas of designated topsoil) shall not exceed 20 acres at any given time. The construction project should be phased to conform with these requirements as well as to minimize the amount of exposed areas, including providing permanent stabilization for disturbed areas prior to progressing to the next stage of construction.

5.2.4 Development of a Stormwater Management Plan (SWMP)

Developing and implementing a SWMP for the construction site is a key step in the planning process. The SWMP is typically prepared during the design phase of the project. Guidelines for SWMP development is covered in the SWMP Preparer Training available from CDOT. Implementation of the SWMP will only be successful if the appropriate control measures are utilized and their effectiveness is monitored.

5.3 STORMWATER MANAGEMENT PLAN (SWMP)

5.3.1 SWMP Requirements

All permittees are required to develop and maintain SWMPs that locate and identify all structural and non-structural control measures for the covered construction activities. Key elements for the SWMP include:

- The SWMP must contain installation, implementation, and maintenance specifications or a reference to the document with installation, implementation, and maintenance specifications for all control measures.
- A narrative description of non-structural control measures must be included in the SWMP.
- The SWMP must be updated often to reflect current conditions.

5.4 TRANSPORTATION EROSION CONTROL SUPERVISORS

Transportation Erosion Control Supervisors (TECS) are Erosion Control Supervisors that have received training focused on CDOT erosion and sediment control practices, and specifications as they related to transportation projects (More information on training and certifications can be found at:

http://h2o.codot.gov/portal_wap/tecs/main/index.aspx).

5.4.1 Keys for being a successful TECS:

- Engage in Frequent Communication: Communication is one of the most important keys to being a successful TECS. Specifications have been developed to require a triad of communication between the TECS, the CDOT Project Engineer, and the site superintendent; and it is imperative that the TECS also communicates frequently with the rest of the construction team. Some of these specifications include:
 - Having the Project Engineer sign off on inspection and audit reports
 - Requiring the triad to attend weekly meetings where stormwater must be discussed
 - Having the triad present at the environmental pre-construction meeting with the CDOT Regional Water Pollution Control Manager and representatives of the project subcontractors.
- Use Tools Such as the Gauntlet: The backbone of stormwater management is identifying potential pollutants on a project, and choosing, installing, and maintaining the appropriate control measures to minimize the potential for that pollutant to enter State Waters or leave the site. The

Gauntlet (below) is a valuable tool that the TECS can use to evaluate which control measure(s) to use, when to use them and how to install and maintain them for maximum effectiveness.

- Use a Proactive Approach: To be successful at managing potential pollutants on a project, a TECS must get appropriate control measures installed prior to the pollutant coming on site or being exposed. If a TECS does not adequately plan in advance of construction, they will have to employ a more reactive approach, and the chance of success will decline. Being proactive will help a TECS communicate more effectively, may reduce project costs, promotes compliance and provides clearer guidance to the subcontractors.

5.4.2 The Gauntlet

The Gauntlet is an easy way to inspect the appropriateness and proper installation of a control measure. A good practice is to start at an outfall and use The Gauntlet as you move backwards through a treatment train to determine potential problem areas.

THE GAUNTLET

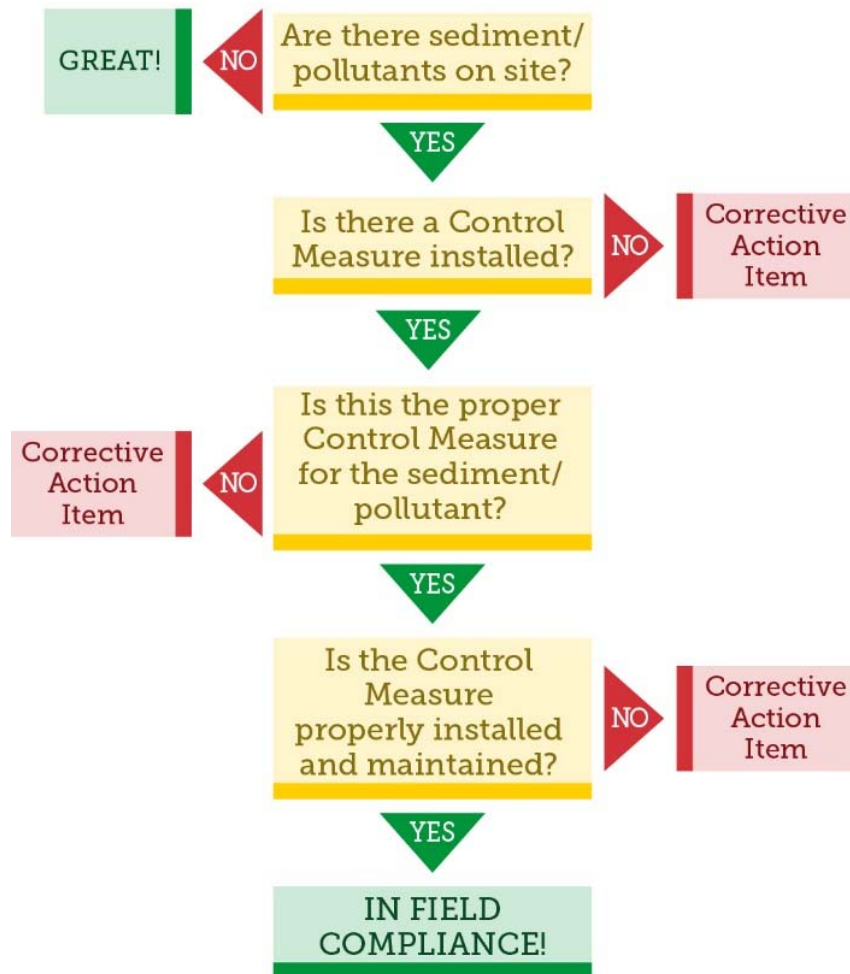

5.5 CONTROL MEASURE SELECTION

There are a wide variety of structural and non-structural control measures that can be used at covered construction sites. Consider this chapter as only guidance in the use of control measures for all phases in the complete project delivery process. Control measures must always be designed using good engineering, hydrologic and pollution control practices, and should meet the following requirements:

- The control measures must be appropriate for the construction site and type of flows expected; they must be implemented prior to the start of construction activities and be sufficient to control potential pollutants during each phase of construction until final stabilization.
- The control measures must be selected, designed, installed, implemented, and maintained to provide control of all potential pollutant sources associated with the permitted construction site to prevent pollution or degradation of state waters or illicit discharges to the Municipal Separate Storm Sewer System (MS4). The potential pollutant sources include, but are not limited to the following:
 - Sediment
 - Construction site waste, such as trash, discarded building materials, concrete truck washout, chemicals, and sanitary waste
 - Contaminated soils
- Control measures must be included in the approved or modified SWMP.

5.6 INSPECTION AND MAINTENANCE

All erosion and sediment control practices and other protective measures identified in the SWMP must always be maintained in effective operating condition. These structures often require routine maintenance to prevent failure during a runoff event, maintenance may be required even after a project might is accepted and closed, as the permits might still be open.

Routine inspections will occur during the site construction; these inspections will be used to determine if the appropriate control measures have been implemented and whether maintenance is required. The frequency and types of inspections are outlined in Chapters 2 and 4 of the Erosion Control and Stormwater Quality Guide.

5.7 CONTROL MEASURE CLASSIFICATION

The recommended control measures explored in this chapter have been classified into four major categories. These categories include the use of structural and non-structural control measure devices and also encompass the use of management strategies for materials and waste products. The four categories include:

- **Erosion Control Measures:** These measures aim to minimize the amount of erosion occurring on disturbed areas until the site is fully stabilized.

CHAPTER 5 CONSTRUCTION CONTROL MEASURES



COLORADO
Department of Transportation

- **Sediment Control Measures:** These Structures aim to capture sediments that have been eroded before they leave the construction site or enter state waters.
- **Temporary Use of Permanent Water Quality Structures:** The use of existing permanent water quality structures may be permitted in a case by case basis; the use of these structures aims to minimize the amount of sediment laden water released into state waters or storm sewer systems.
- **Materials and Waste Management Strategies:** These management strategies aim to provide a better management framework to handle, store and mitigate potential pollution from the use of materials and chemicals during the construction of transportation project.

Table of Contents



CATEGORY	ID	CONTROL MEASURE OR MANAGEMENT STRATEGY	PRIMARY CONTROL MEASURE FUNCTION	TYPICAL TEMPORARY CONTROL MEASURE LIFESPAN
EROSION CONTROL MEASURES	1	Check Dam	Erosion Control Sediment Control	Rock Check Dam~ 12 Months Erosion Log Check Dam~ 3 Months
	2	Mulching (Agricultural Straw or Hay) and Mulch Tackifier	Erosion Control	~ 3 Months
	3	Mulching (Hydraulically Applied)	Erosion Control	~ 3 Months
	4	Rough Cut Street Controls	Erosion Control Sediment Control	~ 3 to 5 Months
	5	Soil Retention Blankets	Erosion Control	~ 9 to 12 Months
	6	Surface Roughening and Vertical Tracking	Erosion Control	~ 2 Weeks to 1 Month
	7	Seeding	Erosion Control Sediment Control	N/A
	8	Temporary Berm	Erosion Control Sediment Control	~ 12 Months
	9	Temporary Diversion	Erosion Control Sediment Control	~ 12 Months
	10	Temporary Slope Drains	Erosion Control	~ 12 Months Unless clogging or undermining
	11	Turf Reinforcement Mats	Erosion Control	N/A
SEDIMENT CONTROL MEASURES	12	Aggregate Bag	Sediment Control Site/Materials Management	~ 6 Months
	13	Brush/Fabric Barrier	Erosion Control Sediment Control	~ 6 Months
	14	Compost Blanket and Compost Filter Berms	Erosion Control Sediment Control	~ 3 Months Depending on precipitation, proper installation and maintenance
	15	Concrete Barrier Control Measure	Sediment Control Site/Materials Management	~ 12 Months Depending on fabric wear
	16	Erosion Bales	Sediment Control Site/Materials Management	~ 3 Months
	17	Erosion Logs	Erosion Control Sediment Control	~ 6 Months
	18	Sediment Trap	Erosion Control Sediment Control Site/Materials Management	~ 12 Months
	19	Silt Dike	Erosion Control Sediment Control Site/Materials Management	~ 12 Months
	20	Silt Fence	Sediment Control	~ 9 Months ~ 3 Months if used for prairie dog protection
	21	Storm Drain Inlet Protection	Erosion Control Sediment Control	~ 12 Months Depending on precipitation
	22	Temporary Slope Breaks	Erosion Control Sediment Control	~ 6 Months
	23	Vehicle Tracking Control	Sediment Control Site/Materials Management	~ 12 Months
TEMPORARY USE OF PERMANENT WATER QUALITY STRUCTURES	24	Temporary Use of Extended Detention Basins (DELETED)	Sediment Control Temporary Retrofit	~ 9 to 12 Months depending on precipitation and maintenance upkeep
	25	Temporary Use of Sand Filter Structures (DELETED)	Sediment Control Temporary Retrofit	~ 9 to 12 Months depending on precipitation and maintenance upkeep
	26	Temporary Use of Filter Drains (DELETED)	Sediment Control Temporary Retrofit	~ 9 to 12 Months depending on precipitation and maintenance upkeep
MATERIALS AND WASTE MANAGEMENT STRATEGIES	27	Concrete Waste Management	Waste Management	~ 12 Months
	28	Materials and Waste Management	Site/Materials Management	N/A
	29	Stockpile Management	Site/Materials Management	N/A

Table of Contents

CATEGORY	ID	CONTROL MEASURE OR MANAGEMENT STRATEGY	PRIMARY CONTROL MEASURE FUNCTION	TYPICAL TEMPORARY CONTROL MEASURE LIFESPAN
CONSTRUCTION SITE MANAGEMENT STRATEGIES	30	Construction Road and Staging Area Stabilization	Erosion Control Sediment Control Site/Materials Management	~12 Months
	31	Dewatering Operations	Sediment Control Site/Materials Management	N/A
	32	Paving Operations	Sediment Control Site/Materials Management	N/A
	33	Protection of Existing Vegetation	Erosion Control Sediment Control	~ 12 Months for Fencing (Plastic)
	34	Scheduling and Coordination of Work	Erosion Control Sediment Control Site/Materials Management	N/A
	35	Street Sweeping and Vacuuming	Sediment Control Site/Materials Management	N/A
	36	Temporary Batch Plant, Onsite	Site/Materials Management	N/A
	37	Vehicle and Equipment Management	Sediment Control Site/Materials Management	N/A
	38	Wind Erosion Control	Erosion Control Sediment Control Site/Materials Management	N/A

1. Check Dam (CD)

1. DESCRIPTION:

Check Dams (also referred to as a ditch check) are temporary control structures that can be constructed from rock, silt berms, or erosion logs. Check Dams can be installed across natural or constructed, and temporary or permanent, drainage ditches. They are intended to reduce the velocity of concentrated flows and reduce erosion potential within the ditch.

2. CONTROL MEASURE USES

- Erosion Control
- Sediment Control
- Site/Materials Management

3. RELEVANT SPECIFICATION SECTIONS

[Section 208](#) - Erosion Control

- a) [208.02. \(e\)/\(f\)](#) - Materials
- b) [208.05. \(g\)/\(h\)](#) - Construction BMPS
- c) [208.11](#) - Method of Measurement
- d) [208.12](#) - Basis of Payment

4. RELEVANT M-STANDARD DETAILS

[M-208-1](#), Sheet 11 of 11 (Rock Check Dam)

[M-208-1](#), Sheet 6 of 11 (Drainage Ditch Applications)

5. BASIS OF PAYMENT

Pay item	Description	Pay Unit
208-00041	Rock Check Dam	EACH
208-00004	Silt Berm	LF

6. APPLICATIONS

- Used to intercept and filter concentrated flows and dissipate erosive energy.
- Used to intercept flows along drainage ditches or channels prior to seeding and during establishment of seeded areas.
- Erosion Logs may be used to temporarily construct Check Dam control measures. Refer to the Erosion Logs fact sheet (No. 17) for more information.



Rock check dam along lined drainage ditch

7. LIMITATIONS

- Use only in open channels that receive runoff from an area 10 acres or less.
- Use only in constructed drainage channels and ditches, never in natural live streams.
- For temporary use only, not to be used as primary sediment capture structures.
- For use in unvegetated channels only, not for use in wetland areas or areas where vegetation has been established as they will damage the existing vegetation.

8. CONTROL MEASURE SOILS TRIANGLE

SOIL TEXTURE AND SUBGRADE CONDITIONS

- APPROPRIATE
- SOMEWHAT APPROPRIATE
- NOT APPROPRIATE

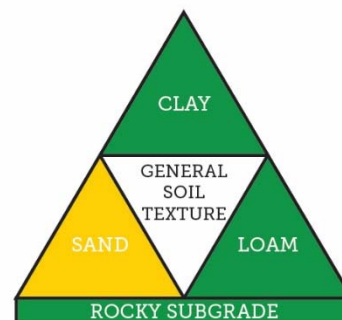

1. Check Dam (CD)



9. SWMP ADMINISTRATOR FOR DESIGN CRITERIA

- Rock Check Dam
 - The local availability and potential hauling cost of the commercially-produced riprap should be considered.
 - Can be installed on soil or hard surface channels.
 - Limit tributary areas to less than 10 acres. If tributary areas are greater than 10 acres, use Project Special Provision Specifications - reinforced rock check dam instead (see UDFCD, Urban Storm Drainage Criteria Manual, Volume 3, page 457) or other appropriate structure as designed by a Professional Engineer.
 - Flow velocities should be a maximum of 12 ft/sec for Rock Check Dams for flow line gradients of 10 percent or less.
 - Rock Check Dams shall be a maximum of 2 feet high with 2:1 structure side slopes and a center weir section 6 inches lower than the edges.
 - Standard Check Dam spacing shall follow the table below:

Flow Line Gradient	2%	3%	4%	5%	6%
Spacing (feet)	100	67	50	40	33

- Rock check dams should not be located within the clear zone distance from edge of pavement for main travel lanes or detours.
- Silt Berm
 - Limit tributary area to less than 10 acres.
 - Flow velocities should be a maximum of 5 ft/sec.
 - Silt Berm shall be lined with UV-stabilized high-density polyethylene and secured with 10- to 12-inch spikes or staples (M-208-1, Sheet 6 Of 11 [Drainage Ditch Applications]).
- Erosion Logs
 - Erosion Logs may be used to construct Check Dam control measures. Check Dam spacing can be calculated by dividing the height of the structure by the slope percentage represented in the decimal form. For additional design and installation criteria refer to the Erosion Logs fact sheet (No. 17).

10. INSTALLATION CRITERIA

- Rock Check Dam:
 - Check Dams are most effective when installed perpendicular to relatively straight sections of an existing ditch or open channels.
 - Careful attention should be given to weir crest elevations and Check Dam spacing.
 - Key in Check Dams a minimum of 6 inches into the ditch or channel bottom and sides.
 - Geotextile fabric must be installed with all Rock Check Dams, following CDOT Standard Details (M-208-1).
 - Place rocks mechanically or by hand to match the designed dimensions; rocks must not be dumped in the ditch or channel.
 - Set weir elevation so that it does not increase flooding depth upstream of Check Dam during 2-year storms or above.
- Silt Berm:
 - Silt Berms are most effective when installed perpendicular to relatively straight sections of an existing ditch or open channels.
 - Clear area of materials greater than 2 inches in diameter.
 - Install Silt Berms on top of soil retention blanket or turf reinforcement mats.

1. Check Dam (CD)



11. MAINTENANCE AND REMOVAL

- Visually inspect for sediment and debris accumulation whenever rainfall is forecasted and after every significant storm event.
- Remove sediment when sediment accumulation reaches half of the structure height.
- Visually inspect for erosion around the edges of the structure and repair immediately.
- Replace any damaged or missing materials as needed throughout project duration.
- When structure is no longer needed or when seeded areas are established, remove and dispose of the structure and accumulated sediment with prior approval from the erosion control supervisor.
- Rock from constructed Rock Check Dams and silt from Silt Berms may be dispersed onsite at locations designated by the Engineer working directly with the Region Environmental Staff. Disposal areas should not impact stabilized ground and existing vegetation or should be stabilized to match existing conditions. Other materials used in the construction of these control measures, such as geotextiles, shall be properly recycled.
- Fill in excavated key-in areas with suitable compacted fill and topsoil and permanently stabilize the disturbance.

1. Check Dam (CD)

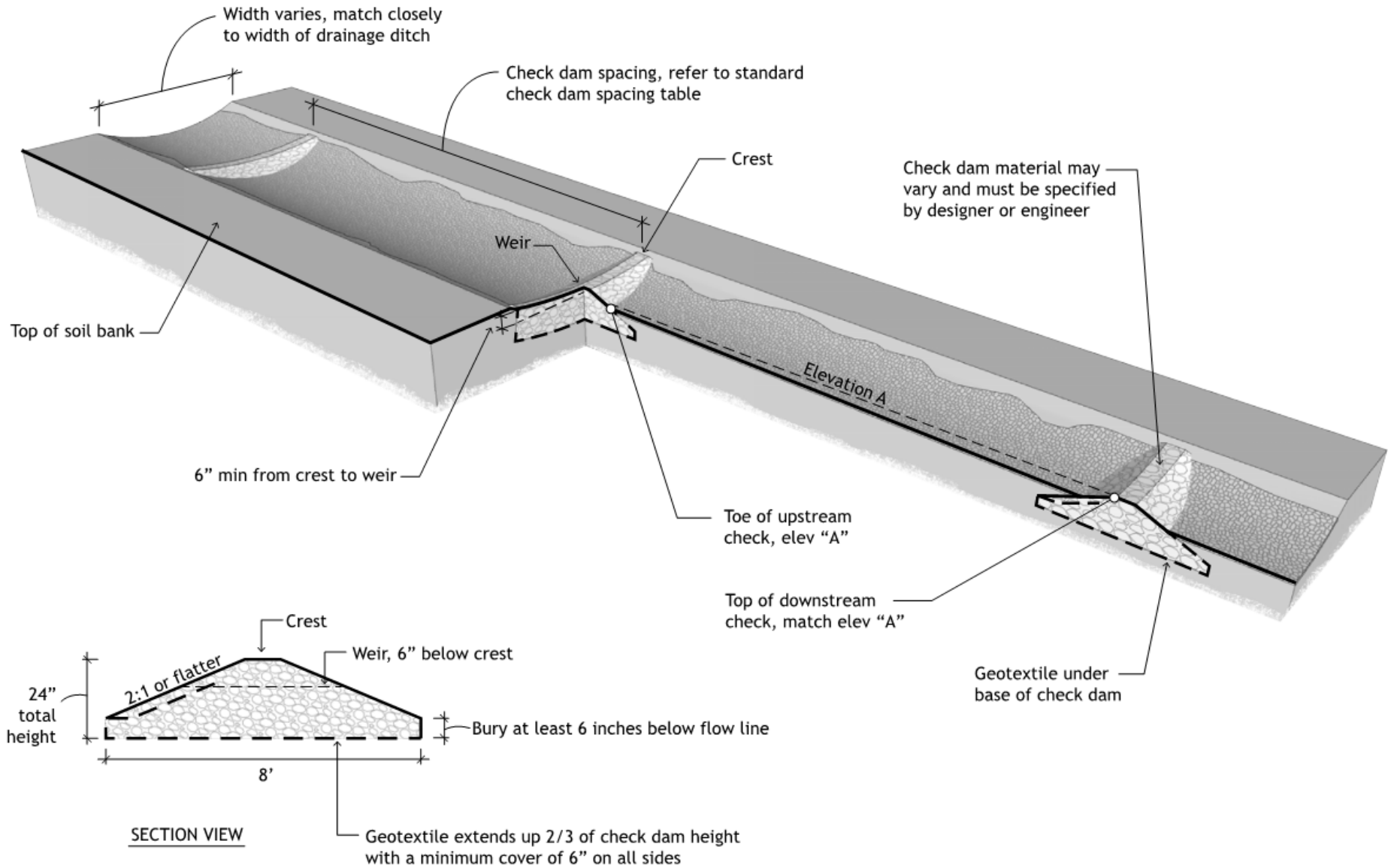

2. Mulching, Agricultural Straw or Hay, and Mulch Tackifier (MU)



1. DESCRIPTION:

Mulching is a temporary control measure used for interim and permanent stabilization that consists of mechanically placing a uniform layer of agricultural straw or hay mulch that is crimped in and sprayed with tackifiers over disturbed construction areas. It protects disturbed areas immediately after seeding from the forces of rainfall impacts; it also increases infiltration. Mulching assists with germination success of seeded areas by conserving moisture and protecting against temperature extremes until permanent vegetation is established.



Straw Mulching on disturbed side slope

2. CONTROL MEASURE OBJECTIVES

- Erosion Control
- Sediment Control
- Site/Materials Management

3. RELEVANT SPECIFICATION SECTIONS

[Section 213](#) - Mulching

- a) [213.02.\(a\)/\(c\)/\(f\)](#) - Materials
- b) [213.03.\(a\)/\(d\)/\(g\)](#) - Construction Requirements
- c) [213.04](#) - Method of Measurement
- d) [213.05](#) - Basis of Payment

4. RELEVANT M-STANDARD DETAILS

Section not applicable for this control measure.

5. BASIS OF PAYMENT

Pay item	Description	Pay Unit
213-00002	Mulching (Weed Free Hay)	ACRE
213-00004	Mulching (Weed Free Straw)	ACRE
213-00061	Mulch Tackifier	LB

6. APPLICATIONS

- Use in conjunction with seeding to protect and stabilize disturbed soil.
- Use to cover disturbed areas for extended periods of time as a stabilization strategy.

7. LIMITATIONS

- Material availability can impact feasibility of this control measure.
- Potential for introduction of weeds and other non-native plant materials.
- Potentially costlier due to increased labor requirements
- Permanent stabilization strategies for slope applications steeper than 2.5H:1V should consider Soil Retention Blanket or Mulching (Hydraulically applied)

8. SOILS TRIANGLE

SOIL TEXTURE AND SUBGRADE CONDITIONS

- APPROPRIATE
- SOMEWHAT APPROPRIATE
- NOT APPROPRIATE

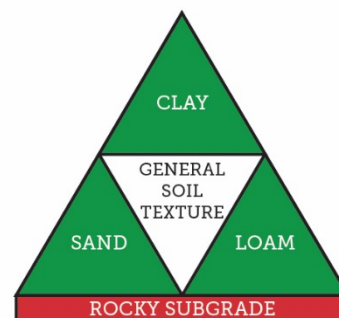

2. Mulching, Agricultural Straw or Hay, and Mulch Tackifier (MU)



9. SWMP ADMINISTRATOR FOR DESIGN CRITERIA

- Tackifier must be used in conjunction with straw mulch in accordance with Section 213.02(c).
- Apply simultaneously or immediately after mulching and crimping to provide uniform coverage.
- Agricultural hay or straw should not be specified in concentrated flow areas either as interim or permanent stabilization. Hay and straw can also clog inlets and should not be used within water quality extended detention basins or sand filter structures.
- Agricultural hay or straw should not be specified in concentrated flow areas either as interim or permanent stabilization.
- Hay and straw can also clog inlets and should not be used within water quality extended detention basins or sand filter structures.

10. INSTALLATION CRITERIA

- Projects within Forest Service ROW or adjacent to sensitive areas might need special approval for the use of agricultural weed free straw or hay.
- Mulch materials should be air-dried and free of impurities in accordance with Section 213.
- For mulched areas to be seeded, native topsoil or approved equal (free of rocks, woody debris or soil clumps) shall be applied to disturbed areas in accordance with Section 207, or a Project Special Provision for Topsoil Management.
- Apply straw mulch at a rate of 1.5 to 2 tons per acre, in accordance with Section 213.
- Mechanically apply mulch at a depth of 1-2 inches. Hand application will require a thicker layer (2-3 inches, or as needed depending upon site conditions).
- Evenly distribute mulch over entire area, with at least 90% coverage.
- Apply mulch according to Section 213 using approved organic tackifier, crimping and anchoring within 4 hours.
- Do not place mulch on drainage channels, walls, sidewalks, pathways, or over existing vegetation.

11. MAINTENANCE AND REMOVAL

- Visually inspect at regular intervals and after every storm event to ensure mulch meets required coverage on all disturbed areas and slopes.
- Apply additional mulch as needed to meet the required soil coverage.
- Apply mulch tackifier with each additional mulching application.
- Manual inspection might be required to ensure appropriate adhesion has occurred.
- Mulching does not need to be removed as it will biodegrade with time.

3. Mulching, Hydraulically Applied (MUH)



1. DESCRIPTION:

Hydraulically Applied Mulch is an interim and permanent stabilization control measure that consists of using hydroseeding equipment to apply a uniform layer of natural fibers and adhesive-like compounds over disturbed construction areas. Hydroseeding immediately protects disturbed areas from rainfall impacts, excessive infiltration, and wind erosion until permanent vegetation is established.

2. CONTROL MEASURE OBJECTIVES

- Erosion Control
- Sediment Control
- Site/Materials Management

3. RELEVANT SPECIFICATION SECTIONS

Section 213 - Mulching

- a) 213.02.(a)/(c)/(f) - Materials
- b) 213.03.(a)/(d)/(g) - Construction Requirements
- c) 213.04 - Method of Measurement
- d) 213.05 - Basis of Payment

4. RELEVANT M-STANDARD DETAILS

Section not applicable for this control measure.

5. BASIS OF PAYMENT

Pay item	Description	Pay Unit
213-00150	Bonded Fiber Matrix	ACRE
213-00151	Bonded Fiber Matrix	LB
213-00012	Spray-on Mulch Blanket	ACRE
213-00013	Spray-on Mulch Blanket	LB

6. APPLICATIONS

- Hydraulically applied mulch along with seeding will protect and stabilize disturbed soil.
- Cover disturbed areas for extended periods, only as interim stabilization, when season does not allow for effective immediate seeding operations.
- It can help retain moisture, aid seed germination, and moderate soil temperatures.



Hydromulch on disturbed side slope

- It is more efficient than hand application of mulch for large-scale projects.
- Low potential of introduction of seeds from manufactured product.

7. LIMITATIONS

- Some products require at least 24 hours drying time before any precipitation to work effectively.
- Do not use in areas of channelized or concentrated flows.

8. SOILS TRIANGLE

SOIL TEXTURE AND SUBGRADE CONDITIONS

- APPROPRIATE
- SOMEWHAT APPROPRIATE
- NOT APPROPRIATE

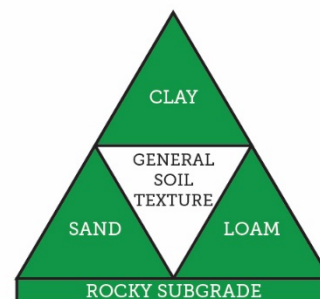

3. Mulching, Hydraulically Applied (MUH)



9. SWMP ADMINISTRATOR FOR DESIGN CRITERIA

- Low potential of introducing seeds from manufactured product for sensitive areas.
- Very effective in areas using imprinting or roughened surfaces (micrograding) as a permanent stabilization strategy.
- Hydraulically applied mulch is best used on dry 2H:1V slopes or flatter.
- Hydraulically applied mulch is not effective when used on saturated soils, areas with seeps, or seasonal springs.
- Due to the high cost associated with equipment mobilization; projects with less than 0.2 acres of disturbance should consider using Soil Retention Blankets instead of Mulching (Hydraulically Applied).

10. INSTALLATION CRITERIA

- Hydraulically applied mulch shall be supplied in a premixed condition by the manufacturer with adhesive-like compounds. Only water should be added in the field.
- Add water to meet the manufacturer's specification, instruction or recommendations, for uniform spread over the seeded area.
- Evenly distribute mulch to cover the entire exposed soil surface.
- Apply from multiple angles to prevent shadow areas.
- Test a small area with hydraulically applied mulch for approval prior to large-scale application.
- Avoid mulch overspray onto the traveled way, sidewalks, lined drainage channels, and existing vegetation.
- Mixing of seed and/or fertilizer with the hydraulically applied mulch products is not an acceptable installation practice for CDOT projects

11. MAINTENANCE AND REMOVAL

- Visually inspect at regular intervals and after every storm event to ensure mulch meets required coverage.
- Spread and hydrate granular hydraulic mulch products in small areas requiring repair from minor damage (e.g., construction traffic and drilling).
- Re-apply hydraulic mulch as needed over failed areas (e.g., large slopes after storm event) throughout the construction period to ensure continuous coverage.
- Mulching does not need to be removed as it will biodegrade with time.

4. Rough Cut Street Control (RCS)



1. DESCRIPTION:

Rough Cut Street Control Measures use Aggregate Bags, Silt Dike, or Temporary Berms along dirt- or road-base stabilized roadways that are under construction or are being used as construction access routes. These control measures are used to intercept and redirect flow away from the roadway.

2. CONTROL MEASURE OBJECTIVES

- Erosion Control
- Sediment Control
- Site/Materials Management

3. RELEVANT SPECIFICATION SECTIONS

No standard specification exists, project will require a Project Special Provision Specification.

4. RELEVANT M-STANDARD DETAILS

No standard detail exists, project will require a project special detail.

5. BASIS OF PAYMENT

Pay item	Description	Pay Unit
N/A	Project Special Provision Specification - Rough Cut Street Control	LF

6. APPLICATIONS

- Use along temporary dirt construction roadways prior to final grading operations or full depth reclamation.
- Use along road base surface roadways that are used for temporary construction access.



Rough Cut Street Control along dirt road - credit to Urban Drainage and Flood Control District

7. LIMITATIONS

- Heavy traffic roadways may require frequent inspections and maintenance.
- May create conflicts around construction access points if not installed correctly.
- Requires a secondary control measure that will receive redirected roadway flows.

8. SOILS TRIANGLE

SOIL TEXTURE AND SUBGRADE CONDITIONS

- APPROPRIATE
- SOMEWHAT APPROPRIATE
- NOT APPROPRIATE

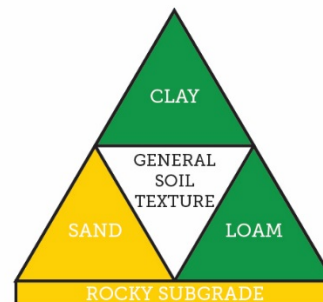

4. Rough Cut Street Control (RCS)



9. SWMP ADMINISTRATOR FOR DESIGN CRITERIA

- Fact Sheets for Aggregate Bag (No. 12) and Silt Dike (No. 19) have separate SWMP Administrator for Design Criteria for their respective sections.
- For dirt surface roads, either Silt Dikes or Aggregate Bags may be used, but proper anchorage should be provided.
- For road base surface roadways, only Aggregate Bags may be used. No anchorage is necessary but continuous inspection and repositioning may be required.
- A secondary control measure, such as a roadside ditch or detention pond should be constructed and available for receiving diverted flows. Ensure secondary control measure is properly placed and downstream of treated roadway and maintained to perform adequately.

10. INSTALLATION CRITERIA

- Position Erosion Logs or Aggregate Bags (barriers) at a slant to the longitudinal roadway slope.
- Alternate placement of barriers extending from the edge to the crown of the road on either side.
- Spacing of these control measures a critical. Suggested spacing is as follows:

Longitudinal Roadway Slope (%)	< 2% to 2%	3% to 4%	5% to 6%	7% to 8%
Recommended Spacing	None to 200 Feet	200 to 150 Feet	100 to 50 Feet	25 Feet

- Suggested dimensions for Structures are as follows:

Roadbed Width	20 to 30 Feet	31 to 40 Feet	41 to 50 Feet	51 to 60 Feet
Recommended Barrier Slant	5 Feet	7 Feet	9 Feet	11 Feet

11. MAINTENANCE AND REMOVAL

- Visually inspect at regular intervals and after every storm to ensure barrier is correctly placed.
- Repair or replace damaged barriers as soon as possible.
- If concentrated flow rills form along the roadway, the spacing between Structures must be reduced.
- Barriers must be removed prior to final roadway grading.
- Aggregate from Aggregate Bags may be dispersed onsite at locations designated by Erosion Control Supervisor or Regional Environmental Staff that do not impact site stabilization.

4. Rough Cut Street Control (RCS)

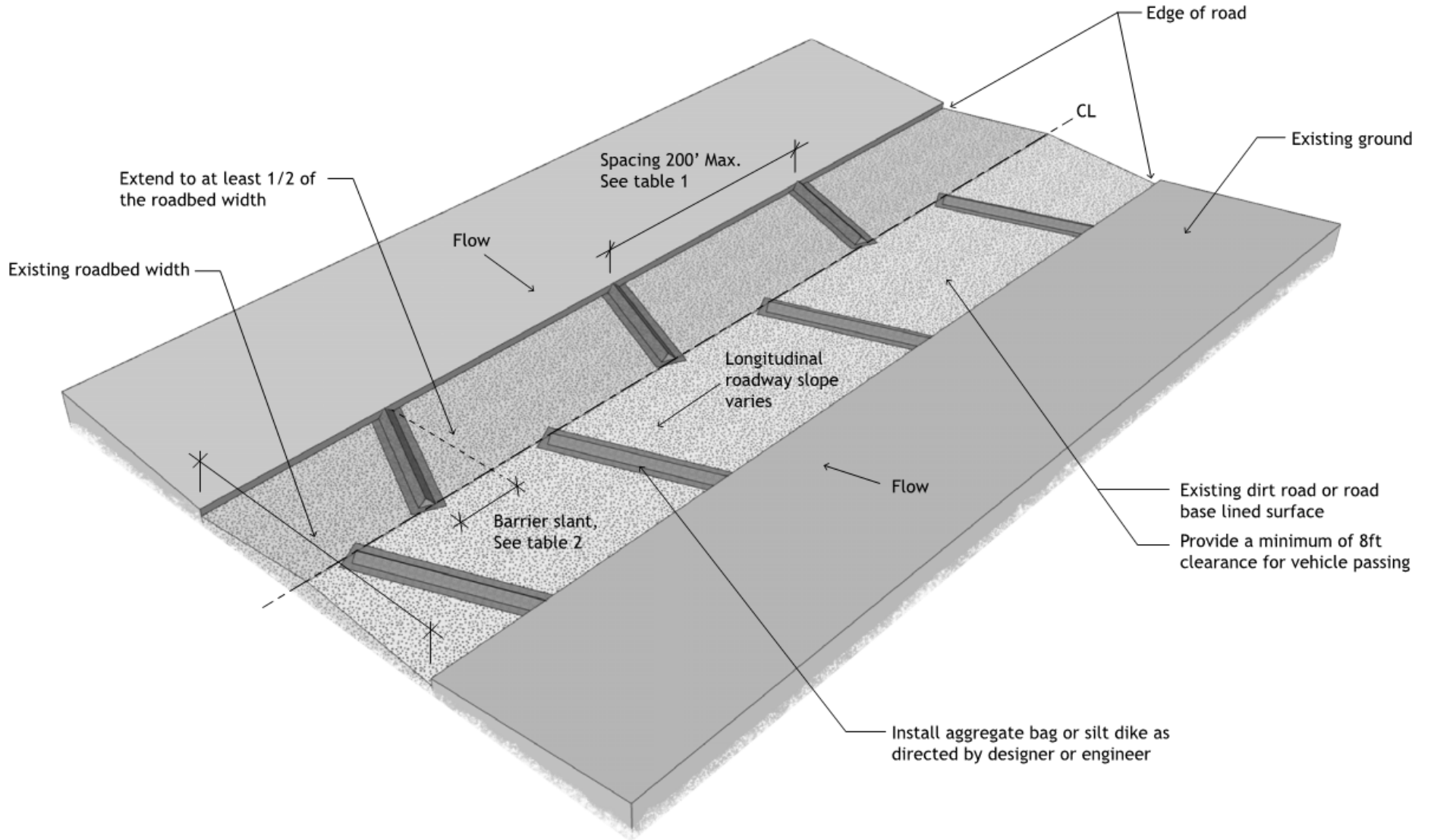

5. Soil Retention Blankets (SRB)



1. DESCRIPTION:

Soil Retention Blankets are control measures made of natural and photodegradable fibrous products. They are temporary control measures aimed to minimize erosion with a protective cover on slopes and channels, and are typically used as an alternative to Mulching (Agricultural Straw or Hay) and Mulching (Hydraulically Applied) until permanent vegetation is established.

2. CONTROL MEASURE OBJECTIVES

- Erosion Control
- Sediment Control
- Site/Materials Management

3. RELEVANT SPECIFICATION SECTIONS

[Section 216](#) - Soil Retention Covering

- a) [216.02.\(a\)/\(f\)](#) - Materials
- b) [216.07](#) - Method of Measurement
- c) [216.08](#) - Basis of Payment

4. RELEVANT M-STANDARD DETAILS

[M-216-1](#), Sheets 1 and 2 of 2 (Soil Retention Blankets/Turf Reinforcement Mats (TRM) Channel Application)

5. BASIS OF PAYMENT

Pay item	Description	Pay Unit
216-00101	Soil Retention Blanket (Straw/Coconut) (Photodegradable Class 1)	SY
216-00111	Soil Retention Blanket (Excelsior) (Photodegradable Class 1)	SY
216-00122	Soil Retention Blanket (Coconut) (Photodegradable Class 2)	SY
216-00201	Soil Retention Blanket (Straw/Coconut) (Biodegradable Class 1)	SY
216-00211	Soil Retention Blanket (Excelsior) (Biodegradable Class 1)	SY
216-00222	Soil Retention Blanket (Coconut) (Biodegradable Class 2)	SY



Soil Retention Blanket application on slopes

6. APPLICATIONS

- Used to minimize wind or water erosion on slopes and channels.
- Thermal consistency and moisture retention for the seedbed area.
- Used to minimize washout of juvenile vegetation that is in the process of establishing itself.
- Serve as an anchor for soils on slopes steeper than 3H:1V.
- Used to minimize erosion on slopes adjacent to receiving waters or hard armored areas.

7. LIMITATIONS

- Improper backfill or installation may cause quick failure of control measure.
- Only a temporary soil stabilization practice. Revegetation is required for long-term stabilization.
- May be more expensive than other Control Measures.

8. SOILS TRIANGLE

SOIL TEXTURE AND SUBGRADE CONDITIONS

- APPROPRIATE
- SOMEWHAT APPROPRIATE
- NOT APPROPRIATE

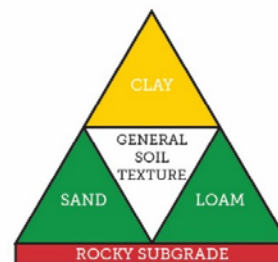

5. Soil Retention Blankets (SRB)



9. SWMP ADMINISTRATOR FOR DESIGN CRITERIA

- Designer must determine type of blanket to be used for every situation based on the following parameters:
 - Slope condition
 - Soils type
 - Allowable maximum shear stress
 - Maximum velocity
- Allowable maximum shear stress and maximum velocity must be calculated for at least the 2-year storm event.
- On sites with very rocky conditions (anticipating over 30 percent of the surface covered with rocks larger than 4 inches in diameter), Soil Retention Blankets should not be used because the blanket will not fully contact the soil.
- Projects with the overall amount of disturbances of less than 0.2 acre should consider using blankets in lieu of Mulching (Agricultural Straw or Hay) and Mulching (Hydraulically Applied) because of the cost to mobilize the equipment needed to install the mulch.
- Projects with the majority of the areas of disturbance less than 6 feet wide should consider using blankets in lieu of Mulching (Agricultural Straw or Hay) and Mulching (Hydraulically Applied).
- The following table presents typical design parameters for Soil Retention Blanket installation; the Engineer must check that these parameters are acceptable for the site based on soil conditions and known runoff patterns:

Ditch Gradient Slope Application Table

	Product Class	Tensile strength MD ASTM D 6818	Maximum Permissible Shear Stress (unvegetated SRB) ASTM D 6460	Ditch Gradient Slope %
SRB	1 ^a	100 lbs/ft	-	> 0 to 2%
	2 ^a	125 lbs/ft	-	
	-	Soil-Loaded Embedded Riprap	Contact Region Hydraulic Engineer	> 5%

^a SRB shall be approved photodegradable or biodegradable blanket.

- Engineer must confirm allowable maximum shear stress and velocities for the site are adequate for the proposed Soil Retention Blanket. Refer to the blanket manufacturer’s standards and specifications.
- For permanent stabilization applications on ditch gradient slopes between 2 and 5 percent, refer to the Fact Sheet for Turf Reinforcement (No. 11).
- Using biodegradable blankets substantially reduces the chance for animal entrapment compared to photodegradable blankets. The Designers may only specify photodegradable blankets when site conditions present a minimal risk for animal entrapment.
- The Designer may specify wooden or biodegradable stakes through the use of a project special provision specification.

10. INSTALLATION CRITERIA

- Soil Retention Blankets must be installed in accordance with CDOT Standard M-216 details.
- Prior to installing the Soil Retention Blanket, place topsoil and complete all final grading, surface preparation, and seeding.
 - Ensure final grade is approved by Engineer prior to the application of Soil Retention Blankets.
 - Ensure soil surface is smooth, with no rocks or dirt clouds bigger than 2 inches on the surface.
 - Apply seed following contract specifications.

5. Soil Retention Blankets (SRB)



- Use a perimeter anchor trench along the outside perimeter of all blanket areas.
- Use a joint anchor trench to join rolls of Soil Retention Blankets together except for straw, which will use an overlapping joint.
- Use an overlapping joint detail to join rolls of Soil Retention Blankets together if they are located on slopes.
- Do not use metal stakes to secure the blanket; use wooden or biodegradable stakes instead.
- In areas where loose soils or rocky subgrade is present, other means of anchoring should be used (duckbill anchors, other proprietary anchoring systems) with prior approval from the Engineer.

11. MAINTENANCE AND REMOVAL

- Visually inspect for signs of erosion or wear at frequent intervals, and before and after a storm event.
- Repair or replace the damaged blanket if it has been torn, pulled out, or otherwise damaged.
- If voids are created beneath the blanket, they must be refilled with soil, reseeded, and mulched.
- Check for damaged, missing, or loose stakes and replace as necessary to secure the Soil Retention Blanket.
- Mowing operations should not occur when the blanketed area is wet as rutting may cause the Soil Retention Blanket to be pulled into the mower blade.
- Soil Retention Blankets are either compostable (made of 100 percent natural fibers) or photodegradable and do not need to be removed from the site.

5. Soil Retention Blankets (SRB)

Roadside Ditch Wetted Perimeter:

Install soil retention coverings over the entire designed wetted perimeter of the ditch (see below).

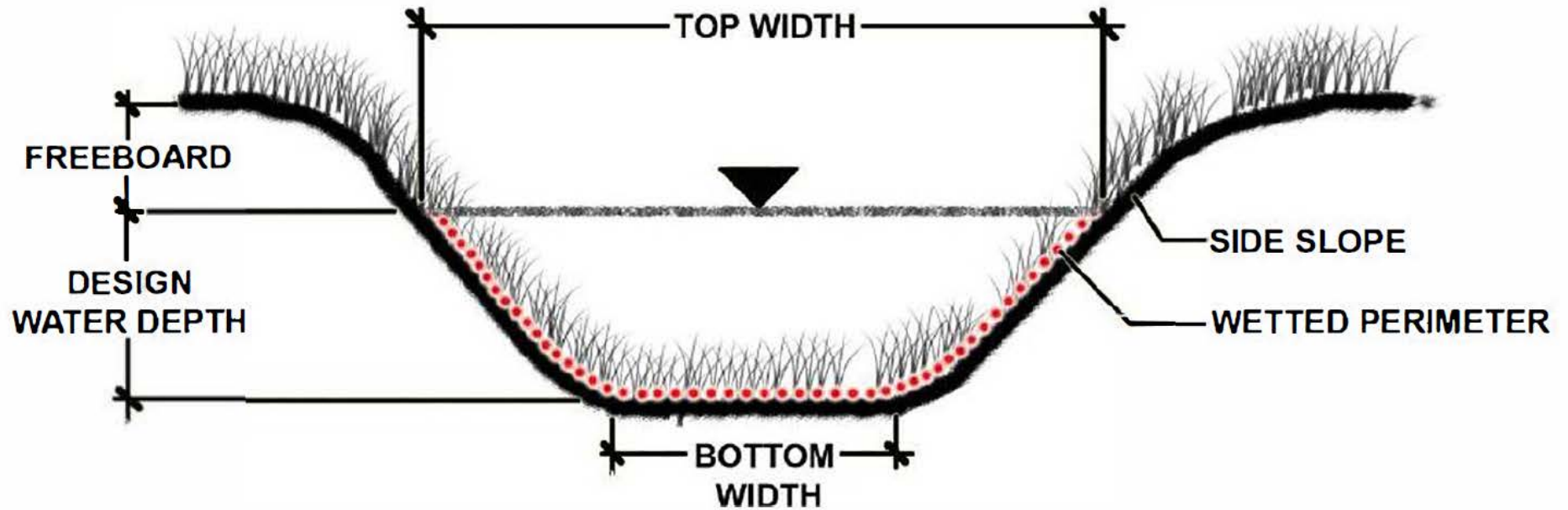

6. Surface Roughening and Vertical Tracking (SR)

1. DESCRIPTION:

Surface Roughening and Vertical Tracking (also referred to a temporary stabilization) are control measure practices that manipulate the subsoil by either creating different textures over the unfinished grade or using a tracked vehicle to drive over the surface, creating horizontal grooves and ridges. Surface roughening texture to the soil surface will reduce runoff velocity, encourage infiltration, and trap sediment..

2. CONTROL MEASURE OBJECTIVES

- Erosion Control
- Sediment Control
- Site/Materials Management

3. RELEVANT SPECIFICATION SECTIONS

[Section 208](#) - Erosion Control

- a) [208.04 \(e\).1](#) - Temporary Stabilization
- b) [208.05 \(s\)/\(t\)](#) - Construction of Control Measures

4. RELEVANT M-STANDARD DETAILS

Section not applicable for this control measure.

5. BASIS OF PAYMENT

Not measured or paid for separately but shall be included in the work.

6. APPLICATIONS

- Used to temporarily stabilize disturbed areas during construction and prior to final stabilization activities.
- Used along disturbed slopes, temporary stockpiles, sediment basins, and/or compacted soil diversion berms.



Vertical tracking on disturbed side slope

7. LIMITATIONS

- Not intended to be used as a standalone control measure. Will required a secondary erosion control measure.
- Only to be used as a temporary means of erosion control.
- Cannot be used on topsoil (spread out on the surface or in stockpiles) because of the compaction.
- Special care must be given to existing utilities around the area when performing roughening operations.

8. SOILS TRIANGLE

SOIL TEXTURE AND SUBGRADE CONDITIONS

- APPROPRIATE
- SOMEWHAT APPROPRIATE
- NOT APPROPRIATE

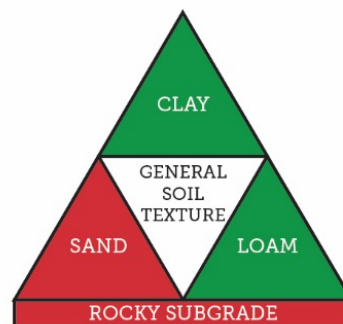

6. Surface Roughening and Vertical Tracking (SR)



9. SWMP ADMINISTRATOR FOR DESIGN CRITERIA

- Surface Roughening is recommended for all smooth graded slopes steeper than 5H:1V.
- Track walking texture must be parallel to the slope contour.
- Surface Roughening techniques may include:
 - **Machine Tracking** on cut or fill slopes in conjunction with grading operations by equipment heavy enough to texture the soil.
 - **Stair-step grading** on erodible material soft enough to be ripped with a bulldozer. Soft rock subgrades with subsoil are optimal for this technique.
 - **Grooving** on cut or fill slopes by tilling, disking, or harrowing, ensuring that grooves are less than 10 inches apart and at least 1 inch deep.

10. INSTALLATION CRITERIA

- Surface Roughening and Vertical Tracking must be provided on disturbed subsoils at the end of each day.
- Where topsoil is to be placed immediately after grading or where topsoil has already been placed, Surface Roughening or Vertical Tracking is **PROHIBITED**.
- Farming disks may not be used to provide surface roughening. It is preferred that ripping or tilling equipment be used along the contours.

11. MAINTENANCE AND REMOVAL

- Inspect site frequently, and before and after storm events, to ensure erosion or riling is not occurring within the small depressions created by tracking or roughening.
- Surface roughening is a temporary control measure and it may be necessary to continue to roughen the area multiple times until topsoil placement and permanent stabilization measures can be implemented.
- When revegetation is planned, subgrade preparation (ripping) is required prior to placing topsoil.

6. Surface Roughening and Vertical Tracking (SR)

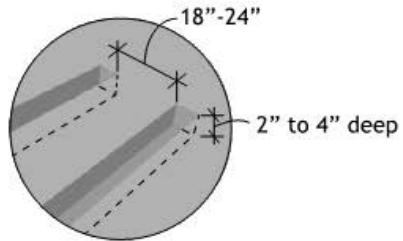

DETAIL

Roughly graded slope

May use machine tracking, stair-step grading or grooving depending on soil conditions

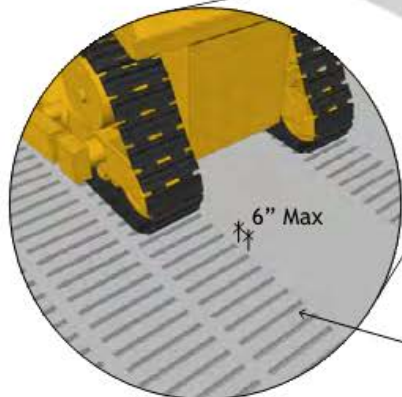
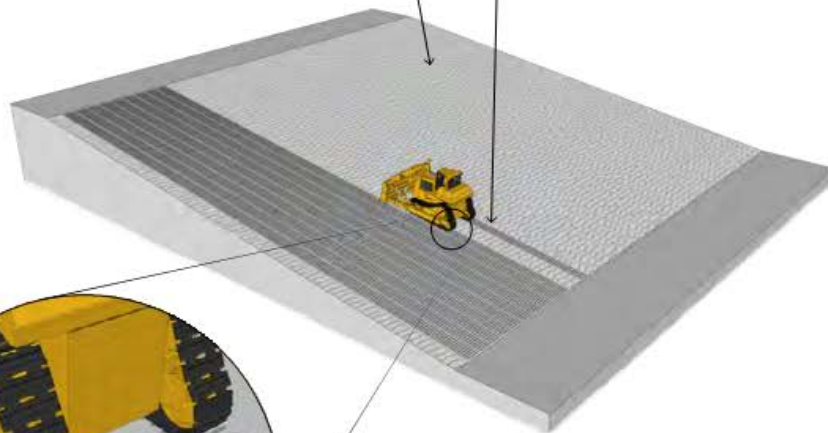

SR - 1. VERTICAL TRACKING
FOR STEEP SLOPES (3:1 OR STEEPER)

Vertical tracks are spaced a maximum of 6 inches and can be up to 4 inches deep

May use machine tracking, stair-step grading or grooving depending on soil conditions

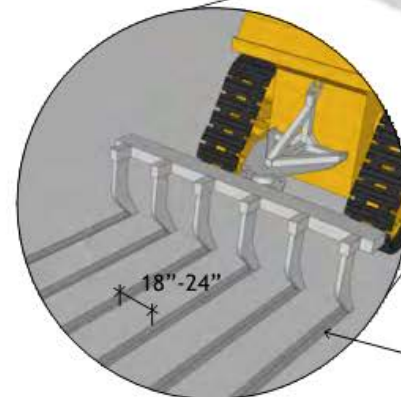
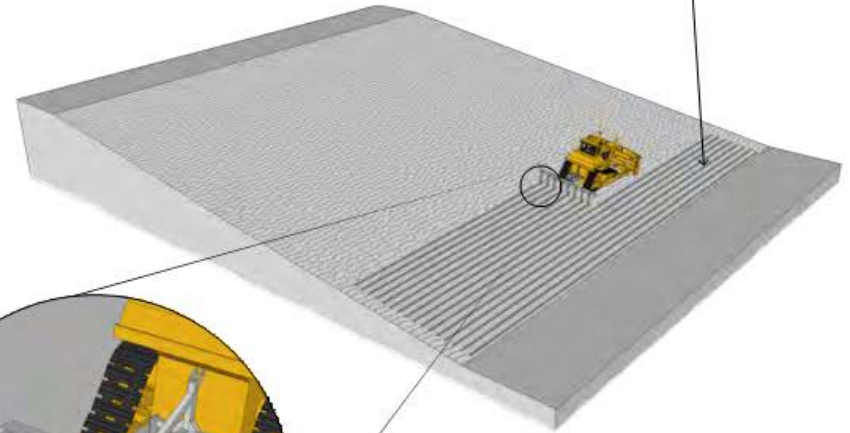

SR - 2. SURFACE ROUGHENING
FOR LOW SLOPES (LESS THAN 3:1)

Roughened rows are spaced a maximum of 6 inches and can be up to 4 inches deep

7. Seeding (TS)

1. DESCRIPTION:

This control measure practice involves the establishment of a permanent, perennial vegetative cover over areas disturbed during construction activities. The main goal of seeding is to stabilize the soil, reduce wind and water erosion, minimize sheet flow and rill erosion, increase infiltration rates, and reduce overall surface runoff.

2. CONTROL MEASURE OBJECTIVES

- Erosion Control
- Sediment Control
- Site/Materials Management

3. RELEVANT SPECIFICATION SECTIONS

[Section 212](#) - Seeding, Fertilizer, Soil Conditioner, and Sodding
[Section 207](#) - Topsoil

4. RELEVANT M-STANDARD DETAILS

Section not applicable for this control measure.

5. BASIS OF PAYMENT

Pay Item	Description	Pay Unit
212-00005	Seeding (Native)	LB
212-00006	Seeding (Native)	ACRE
212-00007	Seeding (Native)(Hydraulic)	ACRE
212-00009	Seeding (Temporary)	ACRE
212-00010	Seeding (Lawn)	LB
212-00011	Seeding (Lawn)	ACRE
212-00015	Seeding (Forbs)	LB
212-00020	Seeding (Forbs)	OZ
212-00022	Seeding (Riparian)	ACRE
212-00025	Seeding (Shrubs)	LB
212-00027	Seeding (Trees)	LB
212-00028	Seeding (Wetlands)	ACRE
212-00009	Seeding (Temporary)	ACRE



Drill Seeder Calibration

6. APPLICATIONS

- Used as part of the permanent stabilization steps for disturbed areas after construction activities are completed.
- Used only after topsoil has been dispersed on the site and soil conditioning amendments are applied.

7. LIMITATIONS

- Permanent stabilization seeding can only be done in the approved seeding season windows for the different elevation ranges in Colorado.

8. SOILS TRIANGLE

SOIL TEXTURE AND SUBGRADE CONDITIONS

- APPROPRIATE
- SOMEWHAT APPROPRIATE
- NOT APPROPRIATE

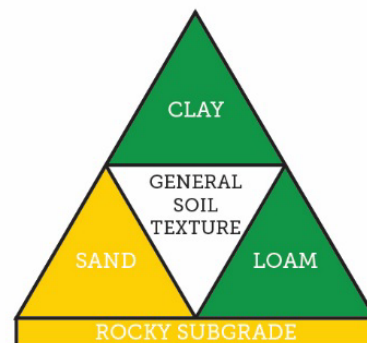

This Control Measure may be appropriate for all soil types with the appropriate installation procedures for topsoil requirements, and other considerations as directed by the Transportation Erosion Control Supervisor or Regional Environmental Staff

7. Seeding (TS)



9. SWMP ADMINISTRATOR FOR DESIGN CRITERIA

- Soil surface preparation must be completed before application of seed.
- To select species for the permanent stabilization see mixes, the Designer should utilize the CDOT Landscape Architecture Section’s Native Seed Calculator, found at: <https://www.codot.gov/programs/environmental/news/native-seed-calculator>
- Topsoil management strategies must be included in the Stormwater Management Plan. These should include locations for the salvaged topsoil as either stock piles or windrow.
- Ground surface should not be compacted nor too loose.
- Temporary seeding consists of planting an annual grass.
- Drill seeding rates for temporary annual grasses are as follows:

Common Name	Botanical Name	Application Time	Seeding Rates (LBS PLS/acre)	Planting Depth (inches)
Oats	Avena sativa	October 1 - May 1	35	1 - 2
Foxtail Millet	Setaria italica	May 2 - September 30	30	1/2 - 3/4

- CDOT has created training videos demonstrating best field practices for landscape architecture pertaining to reclamation, revegetation, and stormwater management to help ensure compliance with CDOT Standard Specifications and CDPHE’s regulations for transportation projects. These videos include guidance for:
 - [Percent Vegetation Cover](#)
 - [Soil Preparation, Ripping and Tilling](#)
 - [Composting and Fertilizers](#)
 - [Drill Seeding Application Rate](#)
 - [Straw Mulching](#)
 - [Crimping and Tackifier](#)

For more information visit the Landscape Architecture Program web page at: <https://www.codot.gov/programs/environmental/landscape-architecture>

10. INSTALLATION CRITERIA

- Drill seeding is the most desirable method.
- Seeding seasons (Section 212.03) must be followed for native seeding.

11. MAINTENANCE AND REMOVAL

- Seeded areas require monitoring to ensure successful germination.
- Seeded areas require protection from vehicle and pedestrian traffic

8. Temporary Berm (TB)

1. DESCRIPTION:

Temporary Berms are temporary control measure barriers made of compacted subsoil or other approved materials such as embankment or sand bags. Their function is to intercept and divert sheet surface runoff away from areas not yet stabilized, prevent erosion, manage sheet flow, and reduce sediment transport.

2. CONTROL MEASURE USES

- Erosion Control
- Sediment Control
- Site/Materials Management

3. RELEVANT SPECIFICATION SECTIONS

[Section 208](#) - Erosion Control

- a) **208.05 (d)** - Construction BMPS
- b) **208.11** - Method of Measurement

4. RELEVANT M-STANDARD DETAILS

[M-208-1](#), Sheet 7 of 11 (Grading Applications)

5. BASIS OF PAYMENT

Pay item	Description	Pay Unit
208-00300	Temporary Berm	LF

6. APPLICATIONS

- May be constructed across roadways (transverse berm) at a slight angle with respect to the centerline.
- May be constructed along the top edge of fill slopes or below the toe of exposed and erodible slopes (upslope or downslope side of a construction area). They can also be used at storm drain inlets (when approved) and across minor swales and ditches.
- May be used to construct Rough Cut Street Control measures.
- May be used to divert surface sheet flows from areas where flows may damage property or interfere with establishment of vegetation.
- May be used to divert surface runoff to other control measures like Sediment Traps.



Temporary Berm along access road

- May be used on relatively flat slopes to capture surface runoff to shorten the overall slope length before it has a chance to concentrate and cause rill and gully erosion

7. LIMITATIONS

- Only to be used as a temporary measure on flat areas with slopes less than 2H:1V.
- Must use a secondary erosion control measure device when sediment control is an objective.
- Susceptible to erosion when intercepted concentrated flows have high velocities.

8. SOILS TRIANGLE

SOIL TEXTURE AND SUBGRADE CONDITIONS

- APPROPRIATE
- SOMEWHAT APPROPRIATE
- NOT APPROPRIATE

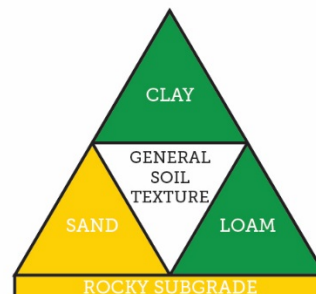

8. Temporary Berm (TB)



9. SWMP ADMINISTRATOR FOR DESIGN CRITERIA

- Temporary Berm:
 - Berm must be at least 18 inches tall or high enough to prevent overtopping.
 - Berm must have a minimum of 4- to 6-foot base.
 - Gradient of all receiving area above berm must be less than 2:1, or flatter.
 - Berms must be designed so that flow line of water is at a gradient of less than 3 percent. Greater than 3 percent may require the use of Check Dams in the flow line behind the berm.
 - Outlets of anticipated flow from captured water behind berms must be designed with additional control measures suitable to control concentrated flow. Maximum drainage area for each outlet must be limited to 2 acres.
 - Berms installed taller than 2 feet require additional control measures at the toe opposite of the conveyance side.

10. INSTALLATION CRITERIA

- Construct Temporary Berm using native subsoil materials that can be compacted. Topsoil may **not be used** to construct these structures.
- Temporary Berm must be compacted manually or by mechanical means.
- The berms shall be constructed at regular intervals along the road and shall be perpendicular to the longitudinal slope from the outer edge of the swale to the crown of the road.

11. MAINTENANCE AND REMOVAL

- Inspect Temporary Berms on a daily basis for signs of erosion, stability, and compaction. Whenever erosion is spotted, replace lost material and recompact berm to match original conditions.
- If intensive maintenance is necessary to keep this control measure functional, consider using a different control measure device (see Silt Dike [fact sheet No. 19] or Erosion Logs [fact sheet No. 17]).
- When upstream area is stabilized, Temporary Berms may be removed. Disturbed area around control measure must be cleared of any debris or sediment, receive subgrade soil preparation, and be seeded and mulched.
- Removed material for Temporary Berms may be distributed on-site at a location approved by the Engineer.

9. Temporary Diversion (TD)

1. DESCRIPTION:

Temporary Diversions are control measures used to reroute water from an existing stream or stormwater drainage path and restrict flows from entering a designated area while construction activities are underway. Temporary Diversion control measures aim to protect water quality by passing uncontaminated upstream flows around active construction areas.

2. CONTROL MEASURE USES

- Erosion Control
- Sediment Control
- Site/Materials Management

3. RELEVANT SPECIFICATION SECTIONS

[Section 208](#) - Erosion Control

- a) [208.05.\(e\)](#) - Construction of Control Measures

4. RELEVANT M-STANDARD DETAILS

[M-208-1](#), Sheet 7 of 11 (Grading Applications)

5. BASIS OF PAYMENT

Pay item	Description	Pay Unit
208-00301	Temporary Diversion	LF

6. APPLICATIONS

- Use to divert irrigation water flows around disturbed ground areas.
- Use to reroute run on stormwater drainage flows around disturbed ground areas.
- Use to divert on-site stormwater flows to appropriate control measures such as sediment traps.



Temporary Diversion

7. LIMITATIONS

- When temporary diversion is not sized properly it may cause unintended concentrated flow discharge and erosion downstream of the control measure.

8. CONTROL MEASURE SOILS TRIANGLE

SOIL TEXTURE AND SUBGRADE CONDITIONS

- APPROPRIATE
- SOMEWHAT APPROPRIATE
- NOT APPROPRIATE

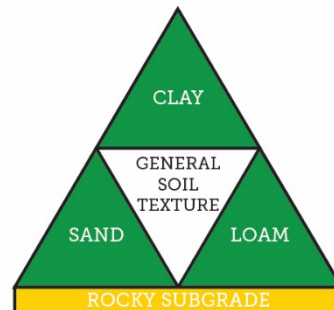

9. Temporary Diversion (TD)



9. SWMP ADMINISTRATOR FOR DESIGN CRITERIA

- When flow must be confined to one side of the stream, a berm or coffer dam may be used.
- Use a piped or pumped diversion for short-duration projects with low base flows.
- Use a coffer or piped diversion designed by a Civil Engineer registered with the state of Colorado to divert the entire waterway for large-scale projects.

Channel Diversion Design

- Ensure drainage area for every slope drain is smaller than 5 acres.
- Determine the design flow rate of the temporary diversion. At a minimum the 2-year storm event should be safely conveyed through the diversion channel.
- Determine the channel slope based on existing and proposed site conditions.

The following diversions must be designed by a Civil Engineer registered with the state of Colorado:

Coffer Dam

- Design the berms to be stable enough for the design flow with the channel shear stress less than the critical tractive shear stress for the channel lining material.
- The steepest permissible side slope is 2:1 unless vertical walls are installed.

Piped Diversion

- Size the pipe to accommodate the design flow rate for the channel diversion.
- The design flow rate should equal no more than 80 percent of the pipe full-flow capacity.

Pumped Diversion

- Choose the pump based on the design flow rate.
- One or more backup pumps with capacity at least equal to the design flow rate should be onsite at all times.

10. INSTALLATION CRITERIA

- Temporary diversion channels on the SWMP shall be installed prior to start of work in downgradient area or natural channels.
- The contractor is responsible for providing Temporary Diversion options for the site along with supporting calculations. Installation procedures for the chosen Temporary Diversion approach must be discussed in the submittal.

11. MAINTENANCE AND REMOVAL

- Diversions must be inspected twice daily—at the start and end of each work day.
- Sediment accumulated within the diversion structure must be removed periodically to ensure conveyance capacity and freeboard are maintained.
- Remove Temporary Diversion after flow has been rerouted through a stabilized natural channel, stormwater ditch, or as sheet flow over a stabilized area.
- Area used for diversion must be restored to existing conditions and stabilized by subgrade soil preparation, topsoil amendments, seeding, and mulching.

9. Temporary Diversion (TD)

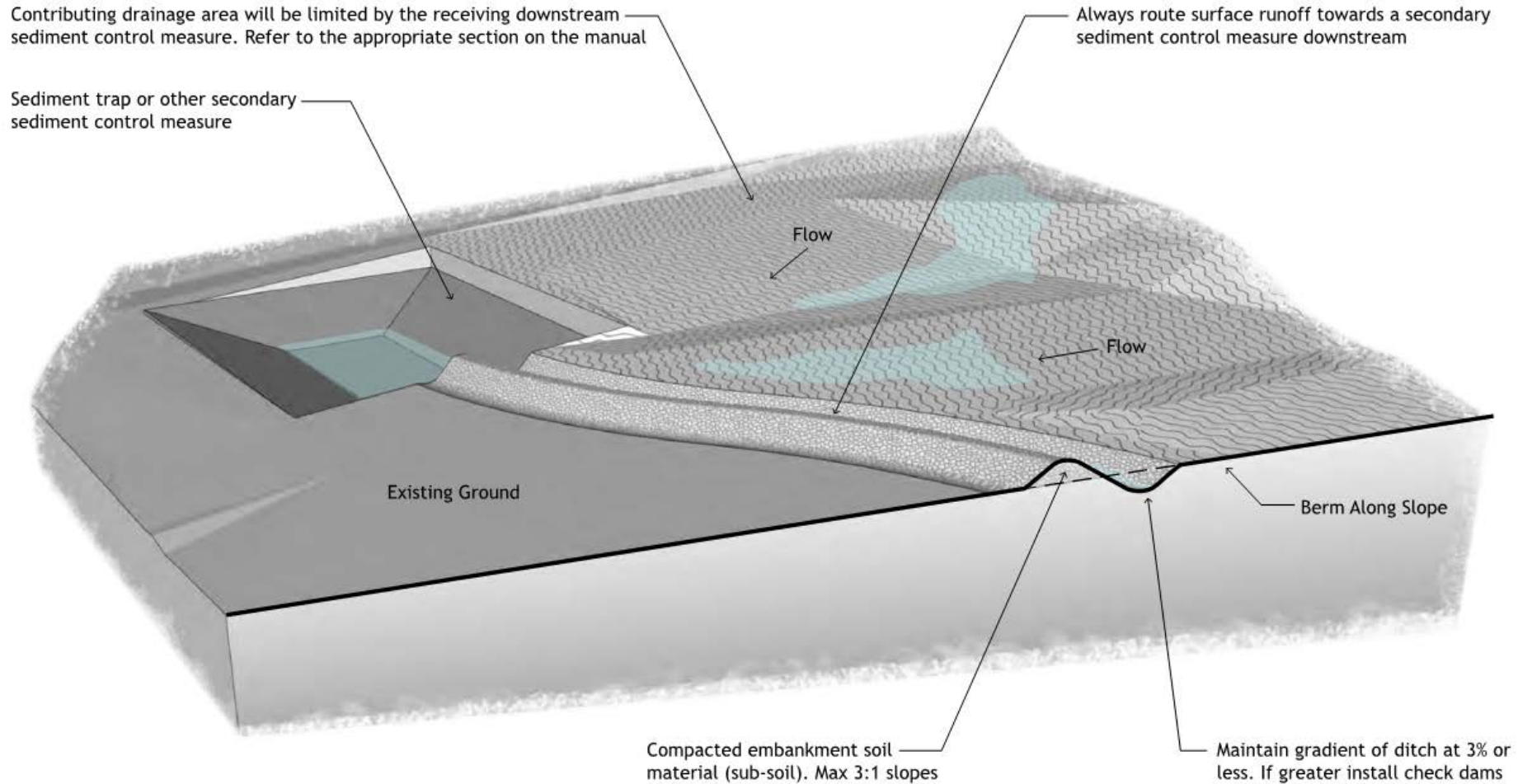

10. Temporary Slope Drains (TSD)



1. DESCRIPTION:

Temporary Slope Drains are control measures consisting of impermeable conduits or channels that contain and carry runoff down a slope on to an energy dissipating discharge point. This control measure should be used whenever concentrated stormwater runoff must be conveyed down a vulnerable steep slope. These structures aim to minimize rill and gully erosion over embankments during construction or until permanent embankment protection is installed or vegetation has been established.



Temporary Slope Drain on stabilized slope

2. CONTROL MEASURE USES

- Erosion Control
- Sediment Control
- Site/Materials Management

3. RELEVANT SPECIFICATION SECTIONS

[Section 208](#) - Erosion Control

- a) [208.02 \(d\)](#) - Materials
- b) [208.05 \(f\)](#) - Construction of Control Measures
- c) [208.11](#) - Method of Measurement
- d) [208.12](#) - Basis of Payment

4. RELEVANT M-STANDARD DETAILS

[M-208-1](#), Sheet 7 of 11 (Grading Applications)

5. BASIS OF PAYMENT

Pay item	Description	Pay Unit
208-00060	Temporary Slope Drains	LF

6. APPLICATIONS

- Used on slopes where erosion potential by surface runoff is considered high.
- Used to convey water down exposed slopes in conjunction with Temporary Diversions (top of slope swales).
- Used to convey concentrated detour paving surface runoff for bridge replacement projects.
- Used on bridge repair projects to collect runoff and pipe to base of fill slopes along bridge approaches. This is useful because there is often a time lag between demoing the existing infrastructure and

constructing the new permanent runoff conveyance system (pavement and pipes) and installing new embankment protection based on the final pavement lifts.

- May be used as an alternative to a Sediment Trap's emergency spillway. appropriate control measures such as sediment traps.

7. LIMITATIONS

- Because flows are concentrated, failure of these structures may cause severe slope erosion.
- May require constant maintenance in areas with constant inflow of sediment-laden runoff.

8. CONTROL MEASURE SOILS TRIANGLE

SOIL TEXTURE AND SUBGRADE CONDITIONS

- APPROPRIATE
- SOMEWHAT APPROPRIATE
- NOT APPROPRIATE

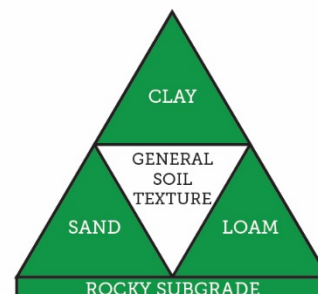

10. Temporary Slope Drains (TSD)



9. SWMP ADMINISTRATOR FOR DESIGN CRITERIA

- Water can be collected and channelized to slope drains with sand bags, silt dikes, berms, or other materials.
- Careful consideration should be given to Temporary Slope Drains installed on slopes steeper than 2.5H:1V to ensure proper energy dissipation is provided at bottom of slope.
 - Energy Dissipation may be designed following CDOT's Drainage Design Manual, Hydraulic Design of Energy Dissipators for Culverts and Channels (FHWA Hydraulic Engineering Circular No. 14), or Hydraulic Design of Stilling Basins and Energy Dissipators (USBR Engineering Monograph No. 25).
- Ensure drainage area for every slope drain is smaller than 5 acres.
- Plastic sheeting, metal or plastic pipe, half round pipe, wood flume, flexible rubber or other approved materials may be used as Temporary Slope Drains.
- For drainage areas larger than 5 acre the pipe size must be designed by an Engineer registered with the state of Colorado to ensure that, at minimum, the drain structure can accommodate the runoff resulting from a 2-year, 24-hour storm event. The proposed use of larger Temporary Slope Drains must be approved.
- The use of prefabricated flared inlet sections on temporary piped slope drains is recommended.
- The outlet must be aligned with the flow direction of the existing grade. Perpendicular discharge to a channel is not acceptable. If 90-degree bends cannot be avoided in the drain pipe, install thrust blocks constructed from sandbags, "t" posts, and wire or other approved materials.
- When using open channels or ditches, these must be lined with properly sized riprap. Refer to CDOT's Drainage Design Manual (Bank Protection) or UDFCD's Urban Storm Drainage Criteria Manual, Volume 1 (8.1 Riprap Sizing).
- Plastic liners may be used to line open channels or ditches. If using a plastic liner, the minimum thickness should be 30 millimeters. Engineer or designer must ensure maximum-allowable shear and velocities comply with the liner manufacturer's specifications.
- If Temporary Slope Drain is conveying sediment-laden water, additional sediment control measures will be needed.
- Additional sediment control measures may be installed downstream of the pipe to minimize sediment transport to downstream features.

10. INSTALLATION CRITERIA

- Accurate installation of these structures is extremely important because failure results in extreme gully erosion and danger to the traveling public during construction.
- For pipe slope drains:
 - Lay pipe over slope and secure inlet and outlet ends.
 - Pipe sections can be connected through fastening or using gasketed watertight fittings.
 - Install sediment control measures upslope of the pipe inlet point to prevent sediment accumulation inside the pipe.
 - Provide energy dissipation (riprap) at the outlet end of the pipe.
- For open channel or ditches:
 - Grade ditch or channel following the minimum parameters specified by the Engineer.
 - Install and secure liner or riprap protection along ditch or channel.
 - Install sediment control measures upslope of the inlet location to minimize need for maintenance.
 - Provide energy dissipation (riprap) at the outlet.

10. Temporary Slope Drains (TSD)



11. MAINTENANCE AND REMOVAL

- All Temporary Slope Drains must be inspected frequently, and before and after every storm event for slope erosion and rill formation as well as proper connectivity between pipe sections, dislodging of riprap, or shift in membrane liner placement.
- If any signs of damage are observed, Temporary Slope Drains must be repaired immediately.
- When pipes are used, periodic inspections should be performed during storm events to ensure conduit is not clogged and provides the desired conveyance capacity.
- Accumulated sediment at the entrance and outfall should be removed promptly. When sediment control measures are used upstream and downstream of Temporary Slope Drains, sediment must be removed when it reaches half the height of the control measure device.
- If riprap shows signs of significant disturbance or dislodging after storm events, consider replacing with larger-diameter riprap as needed.
- After removing the Temporary Slope Drains, the disturbed area must be returned to pre-project conditions, covered with topsoil, seeded, and mulched.
- Slope drain pipes may be cleaned and recycled by the contractor if they preserve their integrity; otherwise they may be disposed of in a landfill.
- Slope drain riprap may be reused onsite to provide permanent energy dissipation for outlets or slopes as deemed necessary. Riprap size must be confirmed by Engineer before installing in other applications.

10. Temporary Slope Drains (TSD)

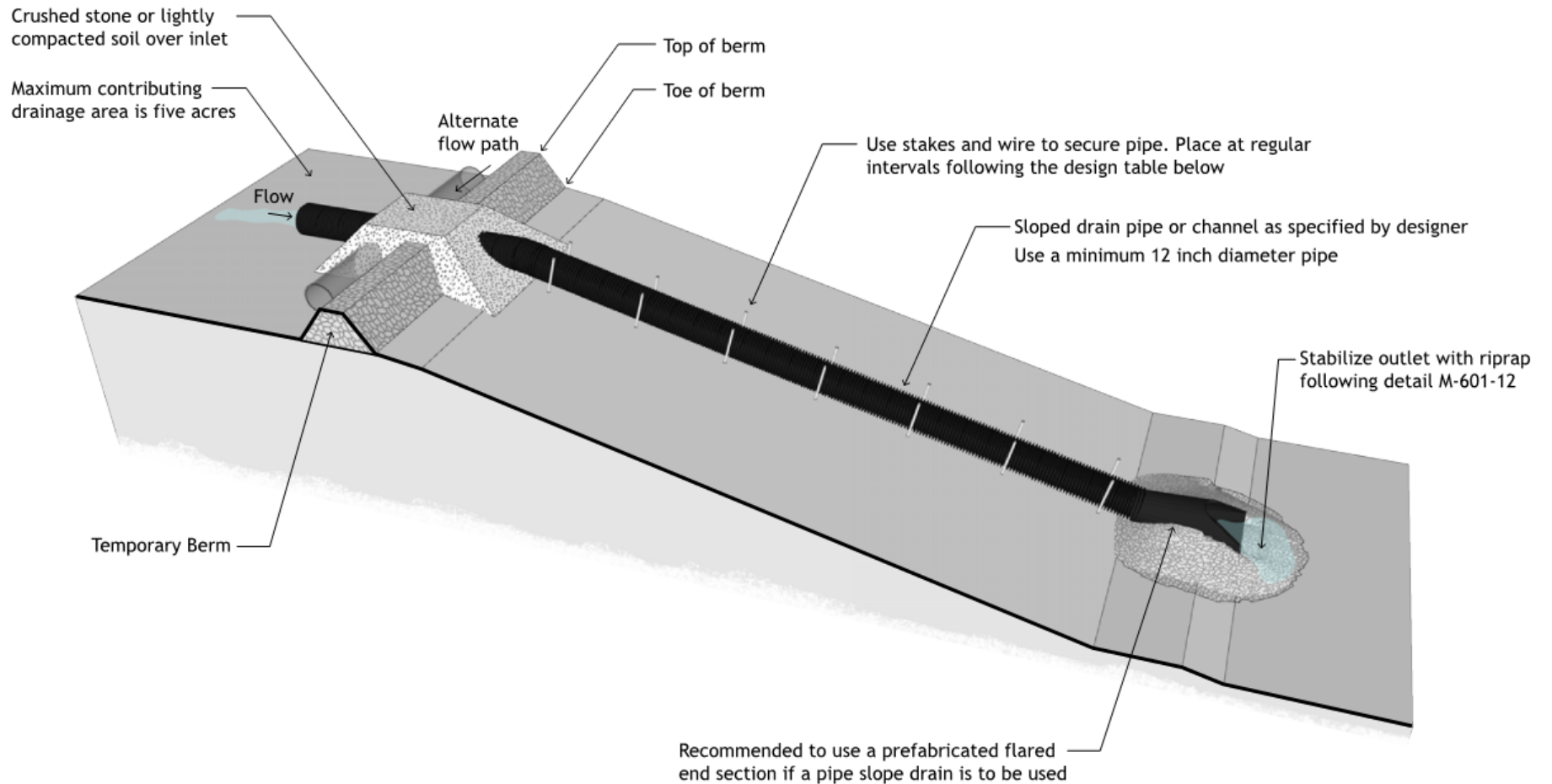

11. Turf Reinforcement Mat (TRM)



1. DESCRIPTION:

Turn Reinforcement Mats are control measures made of nondegradable synthetic netting, processed into a three-dimensional matrix. They are used for long-term slope erosion protection against the shear forces of flowing water in places where vegetation may take a while to establish.

2. CONTROL MEASURE OBJECTIVES

- Erosion Control
- Sediment Control
- Site/Materials Management

3. RELEVANT SPECIFICATION SECTIONS

[Section 216](#) -Soil Retention Covering

- a) [216.02\(b\)](#) - Materials
- b) [216.07](#) - Method of Measurement
- c) [216.08](#) - Basis of Payment

4. RELEVANT M-STANDARD DETAILS

[M-216-1, Sheets 1 and 2 of 2 \(Soil Retention Blankets\)](#)

5. BASIS OF PAYMENT

Pay Item	Description	Pay Unit
216-00301	Turf Reinforcement Mat (Class 1)	SY
216-00302	Turf Reinforcement Mat (Class 2)	SY
216-00303	Turf Reinforcement Mat (Class 3)	SY

6. APPLICATIONS

- Applicable to all scenarios listed under Soil Retention Blankets (fact sheet No. 5).
- Used to minimize wind or water erosion on slopes, channels, ponds, levees, and dams where high flows are expected to consistently exceed soil's maximum permissible velocities.
- May function as permanent support for established vegetation.



Soil loaded Turf Reinforcement Mat along drainage ditch

7. LIMITATIONS:

- Typically Turf Reinforcement Mats are more expensive compared to standard Soil Retention Blankets, for both materials and installation labor.
- Installation of Turf Reinforcement Mats is typically more complex compared to standard Soil Retention Blankets and may require proprietary hardware.

8. CONTROL MEASURE SOILS TRIANGLE

SOIL TEXTURE AND SUBGRADE CONDITIONS

- APPROPRIATE
- SOMEWHAT APPROPRIATE
- NOT APPROPRIATE

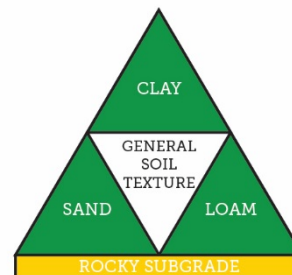

11. Turf Reinforcement Mat (TRM)



9. SWMP ADMINISTRATOR FOR DESIGN CRITERIA

- Turf reinforcement mats should be chosen based on the expected design velocity and shear stress for the application. The table below may be used as general guidance.

Ditch Gradient Slope Application Table

Product Class ^a	Tensile Strength MD ASTM D 6818	Maximum Permissible Shear Stress (Unvegetated TRM) ASTM D 6460	Ditch Gradient Slope %
1	125 lbs/ft	1.8 lbs/ft ²	> 2 to 3%
2	150 lbs/ft	2.5 lbs/ft ²	> 3 to 4%
3	175 lbs/ft	3.1 lbs/ft ²	> 4 to 5%
	Soil-loaded Embedded Riprap	Contact Region Hydraulic Engineer	> 5%

^a All TRM Classes should be backfilled with 1 inch of topsoil and native seed and topped with SRB Class 1 (70 percent straw/30 percent coconut, or 100% coconut fiber) installed as final cover.

- Native seeding should be installed both under the TRM and as part of the topsoil loading on top of the TRM

10. INSTALLATION CRITERIA

- Turf reinforcement mats must be installed in accordance with CDOT standard m-216 details.
- Prior to installing the turf reinforcement mat, place topsoil and complete all final grading, and ensure a smooth surface is present with no significant voids.

11. MAINTENANCE AND REMOVAL

- Visually inspect for signs of erosion or wear frequently until vegetation has established.
- Inspect turf reinforcement mats with regular frequency, before and within 24 hours after a storm event.
- Avoid foot and vehicle traffic over the mat as much as possible, especially in wet/loose soil conditions.
- Repair or replace the turf reinforcement mat if it has been torn, pulled out, or otherwise damaged.
- Voids beneath the turf reinforcement mat must be refilled with soil, reseeded, and mulched.
- Typically, turf reinforcement mats are not removed but rather left in place to enforce long-term stability and support establish vegetation against erosion.
- Mowing operations should not occur when the blanketed area is wet as rutting may cause the turf reinforcement mat to be pulled into the mower blade.

11. Turf Reinforcement Mat (TRM)

Roadside Ditch Wetted Perimeter:

Install soil retention coverings over the entire designed wetted perimeter of the ditch (see below).

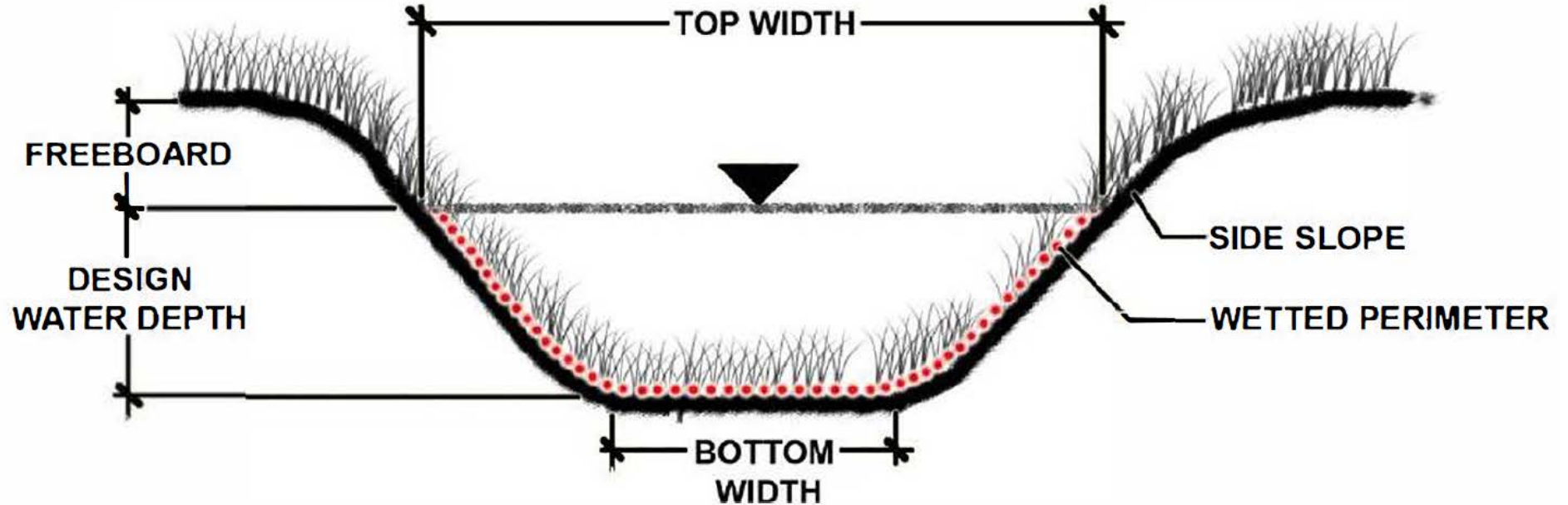

12. Aggregate Bag (AB)



1. DESCRIPTION:

Aggregate Bags are small temporary control structures consisting of crushed stone or recycled-rubber-filled woven geotextile bags. They may be used in multiple scenarios to trap sediment from polluted stormwater runoff resulting from construction activities.

2. CONTROL MEASURE USES

- Erosion Control
- Sediment Control
- Site/Materials Management

3. RELEVANT SPECIFICATION SECTIONS

[Section 208](#) - Erosion Control

- a) [208.02 \(m\)](#) - Materials
- b) [208.05 \(r\)](#) - Construction of Control Measures
- c) [208.11](#) - Method of Measurement
- d) [208.12](#) - Basis of Payment

4. RELEVANT M-STANDARD DETAILS

[M-208-1](#), Sheet 4 of 11 (Aggregate Bag Applications)

5. BASIS OF PAYMENT

Pay item	Description	Pay Unit
208-00035	Aggregate Bag	LF

6. APPLICATIONS

- Where paved surfaces are present, use for perimeter control.
- Install on paved aprons for inlet protection.
- Install on paved curbs as checks, a minimum clearance of 2 feet must be provided from the edge of traveled way to the face of curb.
- May be used as temporary Storm Drain Inlet Protection devices or to construct Rough Cut Street Control devices.



Aggregate Bag used for temporary sediment control

7. LIMITATIONS

- These structures may be used in constructed channels but not in live streams.
- Use on compacted soil surfaces.
- When used, a secondary sediment capture structure must also be installed.
- Do not use these control measures to contain slurry from joint flushing operations.
- Degradation of geotextile fabric may cause contents of bag to spill, requiring cleanup and replacement.

8. CONTROL MEASURE SOILS TRIANGLE

SOIL TEXTURE AND SUBGRADE CONDITIONS

- APPROPRIATE
- SOMEWHAT APPROPRIATE
- NOT APPROPRIATE

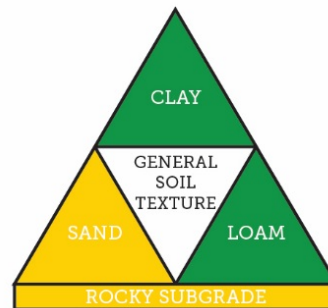

12. Aggregate Bag (AB)



9. SWMP ADMINISTRATOR FOR DESIGN CRITERIA

- Ensure disturbed contributing drainage area is less than 1 acre and has a maximum slope of 3H:1V.
- When used as Storm Drain Inlet Protection device, follow design and installation guidelines outlined in Storm Drain Inlet Protection fact sheet (No. 21).
- When used as Rough Cut Street Control devices, follow design and installation guidelines outlined in Rough Cut Street Control fact sheet (No. 4).
- Aggregate, rubber filler, and woven geotextile fabric must comply with the criteria established in the CDOT standard specifications.

10. INSTALLATION CRITERIA

- Aggregate bags may be bound together using galvanized wire.
- When installed in a gutter adjacent to a curb, ensure aggregate bag does not protrude more than 2 feet from the curb in order for traffic to pass safely.

11. MAINTENANCE AND REMOVAL

- Inspect aggregate bags for displacement and replace as necessary to ensure proper functioning.
- Visually inspect for sediment and debris accumulation whenever rainfall is forecasted and after every significant storm event.
- Sediment must be removed when sediment accumulation reaches half of the bag height.
- Visually inspect for geotextile fabric degradation throughout the duration of construction activities. Replace geotextile fabric immediately to prevent contents from spilling.
- Remove and dispose of the structure and accumulated sediment when the structure is no longer needed. Sediment and aggregate may be dispersed onsite at a location approved by the Engineer. Recycled rubber and geotextile fabric may be disposed of at a landfill or recycling facility.

13. Brush/Fabric Barrier (BB)



1. DESCRIPTION:

Brush/Fabric Barriers are piles of vegetation or mulch that are used to reduce runoff flow velocity and encourage sedimentation.

2. CONTROL MEASURE USES

- Erosion Control
- Sediment Control
- Site/Materials Management

3. RELEVANT SPECIFICATION SECTIONS

No standard specification exists, project will require a Project Special Provision Specification..

4. RELEVANT M-STANDARD DETAILS

No standard detail exists, project will require a project special detail.

5. BASIS OF PAYMENT

Pay item	Description	Pay Unit
--	Brush/Fabric Barrier	LF

6. APPLICATIONS

- Ideal for sites with significant amounts of cleared woody vegetation.
- Can be used at the toe of slopes.
- Can be used along the perimeter of a disturbed area to prevent sediment loading.



Brush Fabric Barrier - Credit West Virginia Department of Environmental Protection

7. LIMITATIONS

- Do not use to treat concentrated flows or large amounts of runoff.
- Do not use in areas with high-velocity runoff.

8. CONTROL MEASURE SOILS TRIANGLE

SOIL TEXTURE AND SUBGRADE CONDITIONS

- APPROPRIATE
- SOMEWHAT APPROPRIATE
- NOT APPROPRIATE

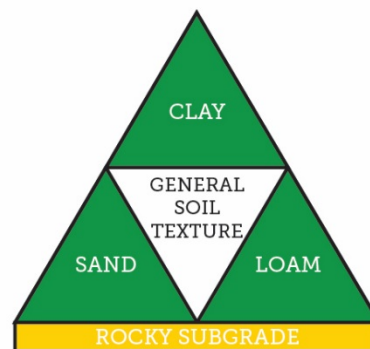

13. Brush/Fabric Barrier (BB)



9. SWMP ADMINISTRATOR FOR DESIGN CRITERIA

- Prior to use, verify that invasive woody species (Russian olive or Tamarisk) are not part of the vegetation that must be cleared and grubbed.
- The vegetation can be mulch (either composted or wood-based), chipped site vegetation, or live cuttings.
 - For cuttings, use only small shrubs and limbs where the diameter is less than 6 inches.
- The mound should be at least 3 feet high and 5 feet wide at its base.
- The drainage area must not exceed 0.25 acre per 100 feet of barrier.
- The slope leading to the barrier must not exceed 3:1 and can be no longer than 150 feet.
- Use geotextile or a natural fabric fiber like burlap and wooden stakes to avoid brush movement.
 - The fabric should be anchored on the downgradient side and with wood stakes.
 - On the upgradient side, the fabric cover should be buried in a trench that is 4 inches deep and 4 inches wide.

10. INSTALLATION CRITERIA

- Ensure no invasive species are present in the barrier, as they may establish themselves.

11. MAINTENANCE AND REMOVAL

- Barrier should be inspected daily to ensure there is no wear or voids.
- Voids should be filled in with additional material.
- Accumulated sediment should be removed regularly.
- If using a fabric, inspect it regularly for damage, and replace and re-secure as required.
- Upon removal, disturbed areas should be covered in topsoil, seed, and mulch.
- With approval by the Engineer, woody vegetation can be dispersed onsite.

13. Brush/Fabric Barrier (BB)

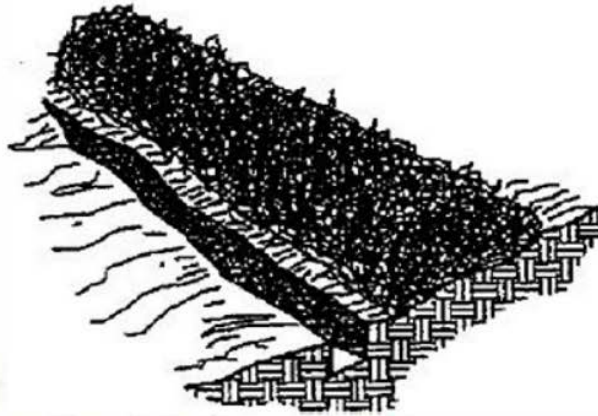

Excavate a 4" x 4" trench along the uphill edge of the Brush Barrier.

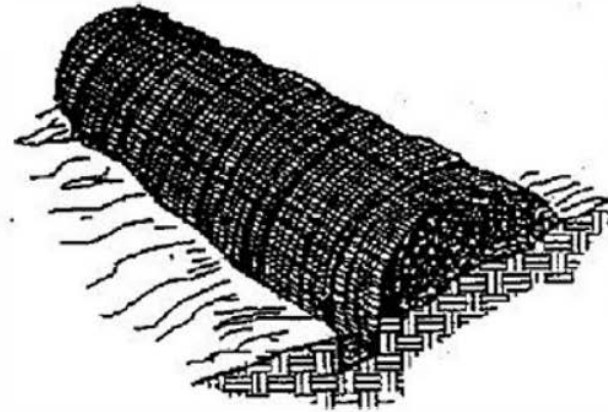

Drape a geotextile over the barrier and into the trench. The geotextile should be secured in the trench with stakes set approximately 36" on center.

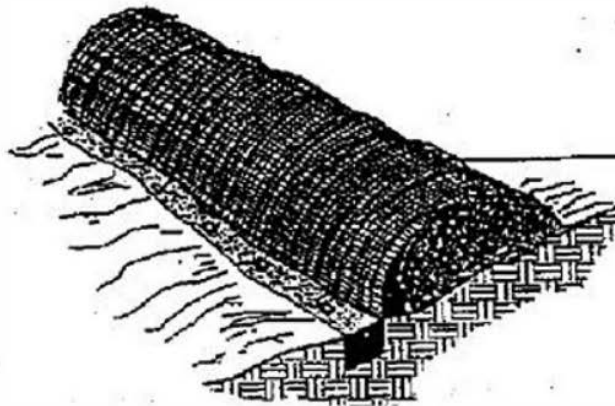

Backfill and compact the excavated soil.

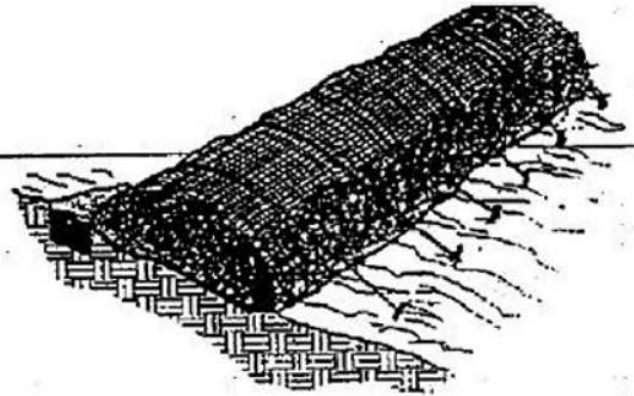

Set stakes along the downhill edge of the barrier, and anchor by tying twine from the geotextile to the stakes.

14. Compost Blanket (CB) Compost Filter Berms (CFB)



1. DESCRIPTION:

Compost Blankets and Filter Berms use compost products such as yard trimmings, food residuals, separated municipal solid waste, biosolids and manure that are applied directly to disturbed areas of soil to reduce the impact of precipitation and water flow velocity; or placed in berms perpendicular to runoff to control erosion and retain sediment.

2. CONTROL MEASURE USES

- Erosion Control
- Sediment Control
- Site/Materials Management

3. RELEVANT SPECIFICATION SECTIONS

No standard specification exists, project will require a Project Special Provision Specification.

4. RELEVANT M-STANDARD DETAILS

No standard details exist, project will require a project special detail.

5. BASIS OF PAYMENT

Pay item	Description	Pay Unit
--	Compost Blanket	ACRE
--	Compost Filter Berm	LF

6. APPLICATIONS

- Compost Blanket is used as an alternative to Soil Retention Blankets on slopes up to 2H:1V.
- Compost Filter Berms are used as an alternative to Silt Fence, Aggregate Bags, Brush Barriers, and Erosion Bales.
- These control measures are used to retain sediment and other pollutants (hydrocarbons and dissolved metals) while allowing filtered water to pass.
- These control measures are used to retain water, promote infiltration, and reduce rill erosion on steep terrain.



Compost Blanket Applications on Slope

7. LIMITATIONS

- Not suitable for areas where large volumes of concentrated flows are likely to occur.
- Good contact between compost and soil should be provided, therefore ground must be cleared, and existing vegetation removed prior to installation of compost control measures.
- The compost material to be used for this control measure must be in accordance with the requirements of CDOT's 212 specification.

8. CONTROL MEASURE SOILS TRIANGLE

SOIL TEXTURE AND SUBGRADE CONDITIONS

- APPROPRIATE
- SOMEWHAT APPROPRIATE
- NOT APPROPRIATE

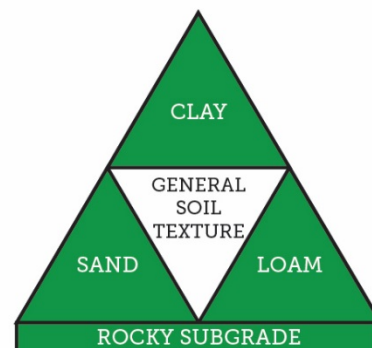

14. Compost Blanket (CB) Compost Filter Berms (CFB)



9. SWMP ADMINISTRATOR FOR DESIGN CRITERIA

- The distance from the project site to a certified commercial composter should be considered during design due to the cost associated with product transport.
- Ensure a maximum velocity of 4 ft/sec or a maximum hydraulic shear stress of 2 lbs/ft² is not exceeded for the area of application.
- To prevent undercutting of blanket, extend area of application at least 10 feet beyond slope.
- Compost mixture should meet all local, state, and federal quality requirements, including compliance with the US Composting Council Seal of Testing Assurance Program for Class I compost. The gradation of the compost should meet the requirements for Erosion Log (Type 2) as stated in CDOT's 212 specification.
- Compost Filter Berm typical dimensions per AASHTO specifications are as follows:

Annual Rainfall Flow Rate	Total Precipitation % Rainfall Erosivity Index	Dimensions for the Compost Filter Berm (height by width) ^a
Low	1 to 25 inches	1 ft by 2 feet to 1.5 feet by 3 feet
Average	26 to 50 inches	1 ft by 2 feet to 1.5 feet by 3 feet

^a Compost Filter Berm dimensions should be modified based on the specific site conditions considering soil type, existing vegetation, slope grade, and length.

10. INSTALLATION CRITERIA

Compost Blanket:

- Compost Blanket shall be applied uniformly to the entire area where erosion control and vegetation are required after topsoil and seed have been placed.
- Apply a uniform 1.5- to 2-inch layer at a rate of 200 to 270 cubic yards per acre.
- For application to slopes steeper than 4:1, area should be tracked or secured with appropriate Soil Retention Blanket.

Compost Filter Berm:

- If a proprietary Compost Filter Berm is to be used, it should follow manufacturer specifications for design and installation.
- Prepare terrain by smoothing surface and removing existing vegetation.
- Construct Compost Filter Berm following the dimensions specified by the project special detail; install Compost Filter Berm perpendicular to flow.



Compost Berm Applications

14. Compost Blanket (CB) Compost Filter Berms (CFB)



COLORADO
Department of Transportation

11. MAINTENANCE AND REMOVAL

- Visually inspect at regular intervals and after every storm to ensure Control Measure is properly installed.
- If damage occurs that prevents vegetation from establishing, compost and seed should be reapplied until stable.
- If rill erosion or gullies form in the control measure, ground must be regraded prior to application of Compost material.
- Contractor should remove sediment from Compost Filter Berm once it has reached half the height of the structure or if sediment restricts flow-through.
- Approved compost may be dispersed and incorporated into topsoil on site prior to seeding.

14. Compost Blanket (CB) Compost Filter Berms (CFB)

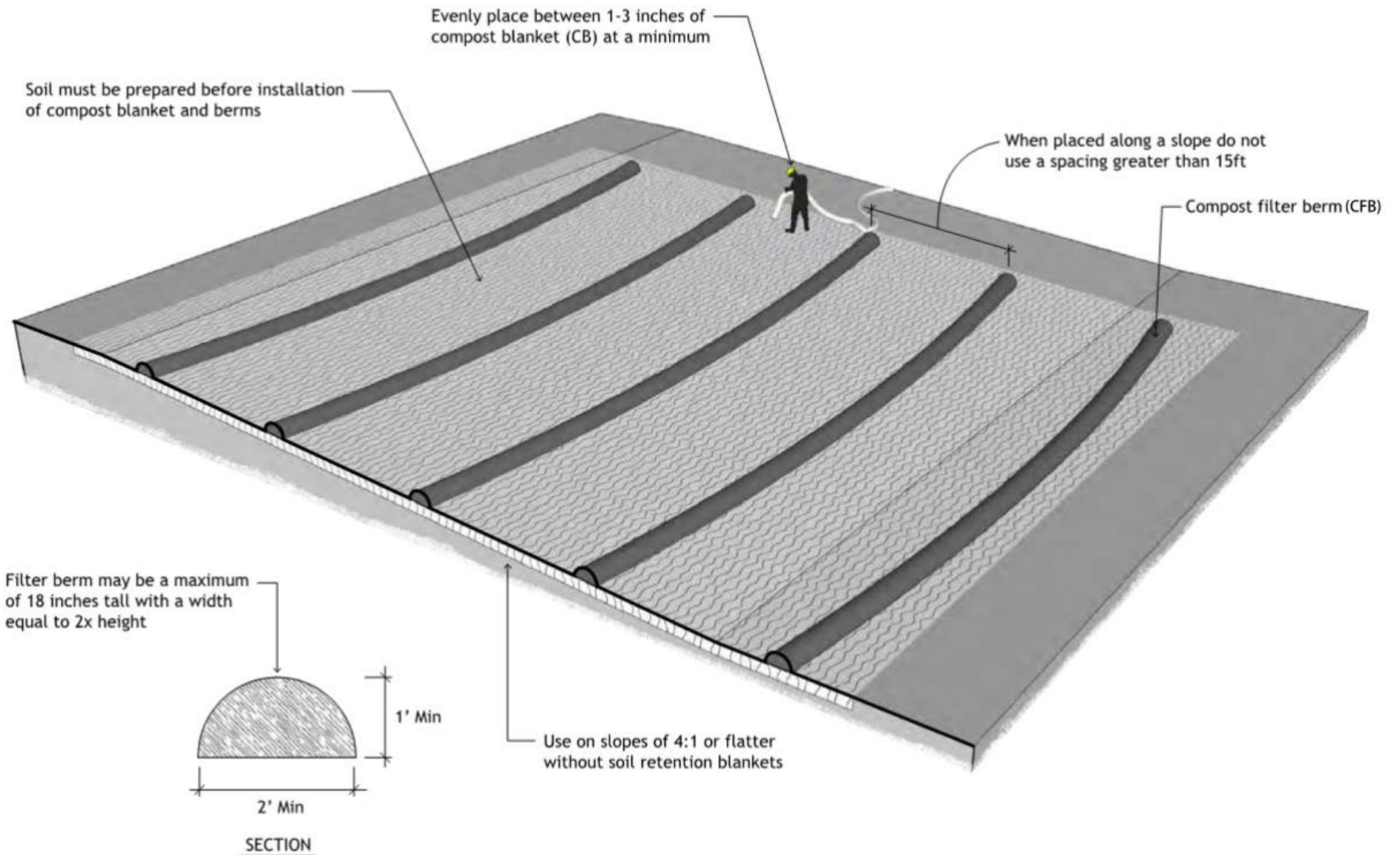

15. Concrete Traffic Barrier with Geotextile (CBC)

1. DESCRIPTION:

Concrete Traffic Barrier with Geotextile is a project special control measure to be used only when approved by the Engineer, as sediment and perimeter control along staging areas and construction site perimeter near rivers or high-traffic roadways where the potential for rock dislodgment is high and where traditional Silt Fence will not be applicable.

2. CONTROL MEASURE USES

- Erosion Control
- Sediment Control
- Site/Materials Management

3. RELEVANT SPECIFICATION SECTIONS

No standard specification exists, project will require a Project Special Provision Specification.

4. RELEVANT M-STANDARD DETAILS

No standard detail exists, project will require a project special detail.

5. BASIS OF PAYMENT

Pay item	Description	Pay Unit
--	Concrete Barrier with Geotextile	LF

6. APPLICATIONS

- To be used in lieu of traditional Silt Fence as detailed in CDOT M-208-1.
- Used to capture sediment and large-diameter rock that may otherwise enter construction site or impact adjacent waterways or roadway.



Concrete Barrier along Creek

7. LIMITATIONS

- The use of this control measure requires prior approval from Engineer, and Erosion Control Supervisor or Regional Environmental Staff, prior to installation.
- Cost per linear foot of this control measure is higher than other traditional control measures and thus should only be used for long-term construction projects.
- Impacts to existing terrain and vegetation are more significant compared to other traditional control measures.

8. CONTROL MEASURE SOILS TRIANGLE

SOIL TEXTURE AND SUBGRADE CONDITIONS

- APPROPRIATE
- SOMEWHAT APPROPRIATE
- NOT APPROPRIATE

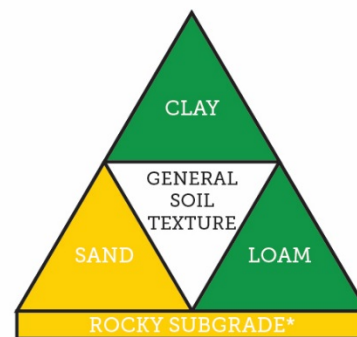

*Only install when level base can be provided

15. Concrete Traffic Barrier with Geotextile (CBC)



9. SWMP ADMINISTRATOR FOR DESIGN CRITERIA

- Contractor should use a Type 4 or Type 7 concrete construction barrier wrapped in woven geotextile.
- Recess barrier away from any water bodies at least above the high-water mark or the 100-year floodplain.
- At least 24-Inches of Barrier should be exposed on the slope side of the treatment.

10. INSTALLATION CRITERIA

- Prepare ground to provide a level surface where barrier will sit.
- Use J-hooks or barrier pins to connect concrete construction barriers
- Ensure scuppers are clear of sediment to allow for drainage.

11. MAINTENANCE AND REMOVAL

- Visually inspect weekly and after every storm to ensure Barrier is installed properly.
- Repair tears in geotextile using duct tape, staples, or patching over with geotextile material.
- After construction activities have concluded, remove concrete barriers for reuse and dispose of geotextile liner in a landfill. Impacted ground shall be loosened and stabilized to pre-project conditions.

15. Concrete Traffic Barrier with Geotextile (CBC)

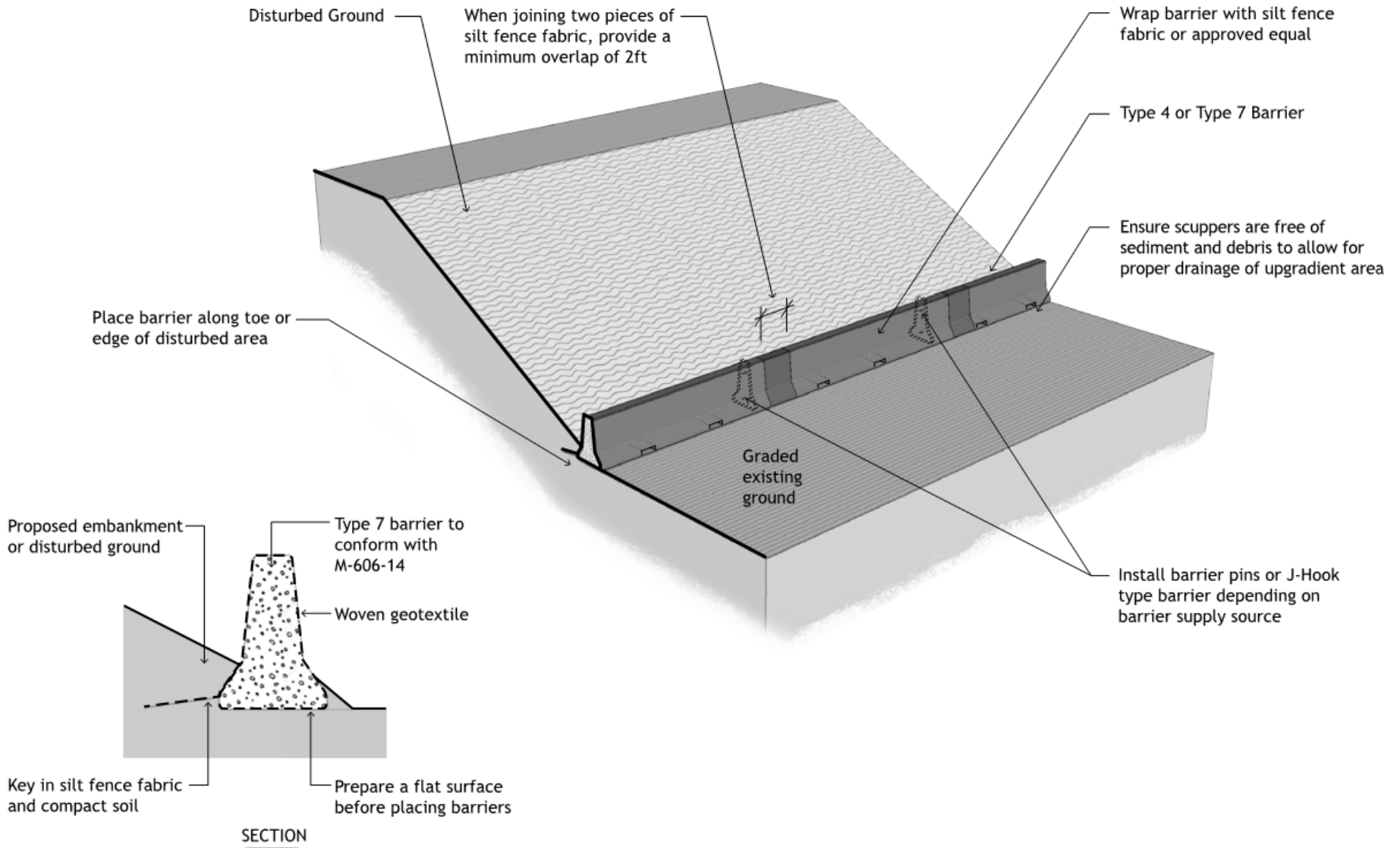

16. Erosion Bales (EB)



1. DESCRIPTION:

Erosion Bales are temporary sediment control structures consisting of a row of entrenched and anchored weed free straw or hay bales.

2. CONTROL MEASURE USES

- Erosion Control
- Sediment Control
- Site/Materials Management

3. RELEVANT SPECIFICATION SECTIONS

[Section 208](#) - Erosion Control

- a) **208.02.(a)** - Materials
- b) **208.12** - Basis of Payment

4. RELEVANT M-STANDARD DETAILS

[M-208-1](#), Sheet 10 of 11 (Erosion Bale Applications)

5. BASIS OF PAYMENT

Pay item	Description	Pay Unit
208-00011	Erosion Bales (Weed Free)	EACH

6. APPLICATIONS

- Install along toe of fill areas to use as temporary filters.
- Use to intercept runoff from ditches, swales, and sump areas.
- Use for Temporary Storm Drain Inlet Protection devices.

7. LIMITATIONS

- May be installed in constructed ditches but not in live channels.
- When these structures are used, a secondary sediment control measure must be installed.
- Effectiveness is reduced after 3 months of use.



Erosion Bales installation around area inlets

8. CONTROL MEASURE SOILS TRIANGLE

SOIL TEXTURE AND SUBGRADE CONDITIONS

- APPROPRIATE
- SOMEWHAT APPROPRIATE
- NOT APPROPRIATE

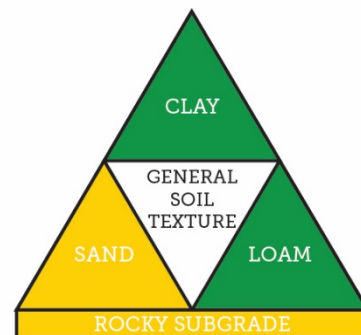

16. Erosion Bales (EB)



9. SWMP ADMINISTRATOR FOR DESIGN CRITERIA

- Ensure disturbed contributing drainage area is less than 0.25 acre per 100 linear feet of Erosion Bale and has a maximum exposed slope of 2H:1V.
- Maximum runoff velocities must not exceed 1 cfs for areas in any installation scenario.
- When used as Storm Drain Inlet Protection device, follow design and installation guidelines outlined in the Storm Drain Inlet Protection fact sheet (No. 21).

10. INSTALLATION CRITERIA

- When used as Storm Drain Inlet Protection, follow the installation criteria as outlined in the Storm Drain Inlet Protection fact sheet (No. 21).
- Trench to a minimum depth of 4 inches, and place Erosion Bale and backfill behind the barrier and around the perimeter up to 4 inches against the uphill side.
- Stake Erosion Bale using at least two wooden stakes driven into the ground a minimum of 1 foot. Stakes must be placed in such a way as to force Erosion Bales together.
- If gaps are present between Erosion Bales, fill in gaps with weed-free straw to prevent water from flowing through.
- When installed around culvert inlets, key Erosion Bale into fill slope adjacent to the pipe end section.
- When installed along the toe of fills, offset Erosion Bales at least 5 feet from toe of slope. Install parallel to the contours.

11. MAINTENANCE AND REMOVAL

- Visually inspect at regular frequency for degradation throughout the duration of construction activities. Replace Erosion Bales immediately to maintain proper functioning.
- Replace Erosion Bales as necessary but at a minimum frequency of once every 3 months to maintain sediment capture capacity.
- When barrier is no longer needed, remove and dispose of the structure and accumulated sediment.
- After removal, trenches must be filled in, seeded, and mulched.
- Sediment and straw may not be dispersed onsite unless approved by the Engineer.

16. Erosion Bales (EB)

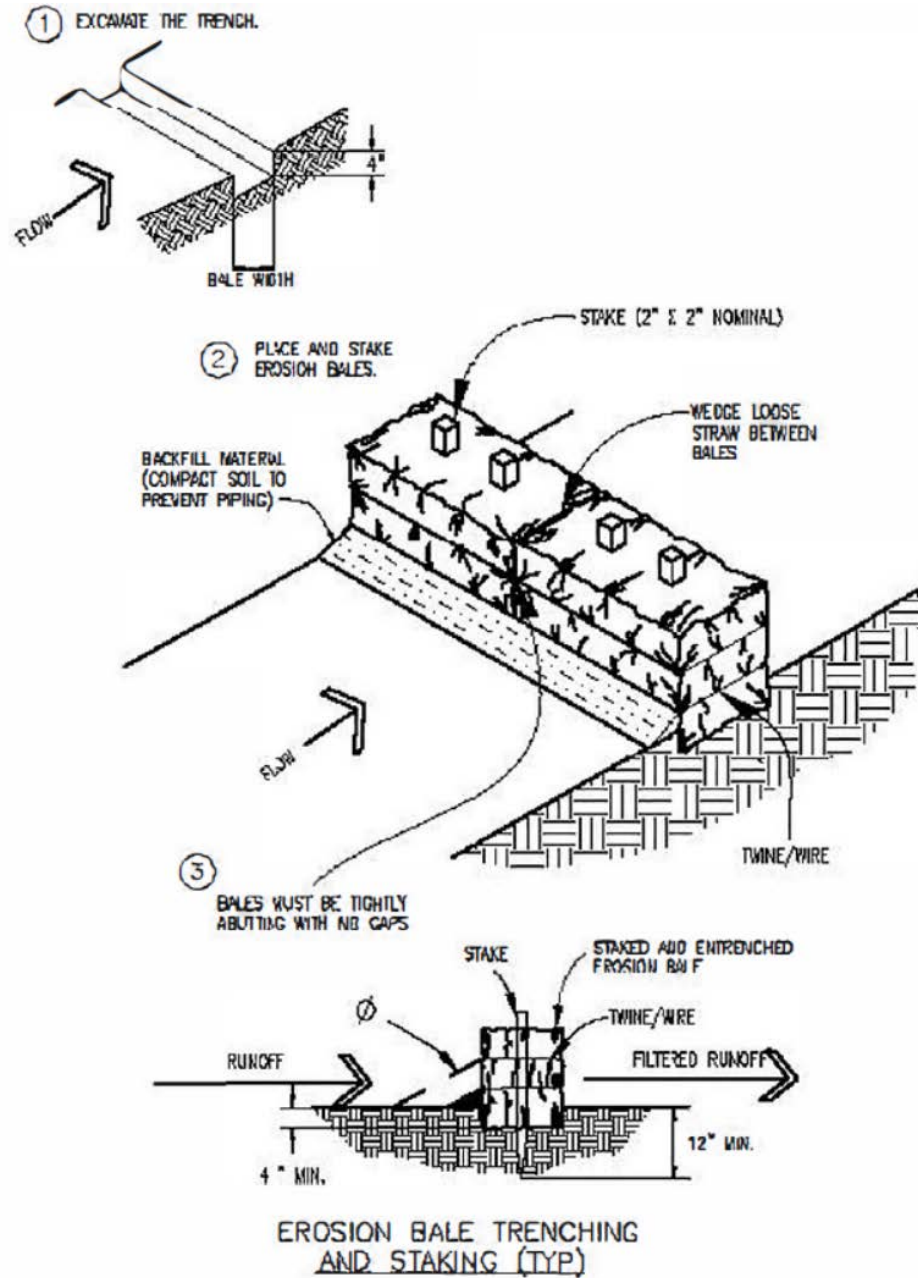

17. Erosion Logs (EL)



1. DESCRIPTION:

Erosion Logs are temporary control measures consisting of a bound cylindrical bundle of a combination of excelsior, straw, coconut fibers, wood chips, or compost and anchored to the ground with wooden stakes. It is used to reduce flow velocities, capture sediment and release runoff as sheet flow over stabilized areas.



Erosion Logs along construction access road

2. CONTROL MEASURE USES

- Erosion Control
- Sediment Control
- Site/Materials Management

3. RELEVANT SPECIFICATION SECTIONS

[Section 208](#) - Erosion Control

- a) [208.02 \(h\)](#) - Materials – Erosion Logs
- b) [208.05 \(I\)](#) - Construction BMPs
- c) [208.11](#) - Method of Measurement
- d) [208.12](#) - Basis of Payment

4. RELEVANT M-STANDARD DETAILS

[M-208-1](#), Sheet 2 of 11 (Erosion Log Applications)

[M-208-1](#), Sheet 3 of 11 (Toe of Slope Protection Applications)

[M-208-1](#), Sheet 6 of 11 (Erosion Log Installations)

5. BASIS OF PAYMENT

Pay Item	Description	Pay Unit
208-00012	Erosion Log Type 1 (9 inch)	LF
208-00002	Erosion Log Type 1 (12 inch)	LF
208-00013	Erosion Log Type 1 (20 Inch)	LF
208-00007	Erosion Log Type 2 (8 Inch)	LF
208-00008	Erosion Log Type 2 (12 Inch)	LF
208-00009	Erosion Log Type 2 (18 Inch)	LF
208-00022	Erosion Log Type 3 (9 Inch)	LF
208-00023	Erosion Log Type 3 (12 Inch)	LF
208-00024	Erosion Log Type 3 (20 Inch)	LF
208-00026	Coir Roll	LF

6. APPLICATIONS

- Use to intercept surface runoff, reduce flow velocities, and capture sediment.
- Where long slopes are present and at grade breaks, use Erosion Logs to prevent formation of concentrated flow paths.
- Upgradient of stormwater inlets, use Erosion Logs to filter sediment and capture debris.
- When vegetation hasn't established, use Erosion Logs as check dams in small drainage ditches.
- Use as perimeter control for stockpiles locations.

7. LIMITATIONS

- In ditches where continuous flows are expected, avoid using Erosion Logs
- Do not use below the ordinary high-water mark for stream applications.
- Can be dislodged after a storm event if appropriate anchoring is not provided.
- Only use as a temporary measure as bounding net is biodegradable and will release contents when degraded.

8. CONTROL MEASURE SOILS TRIANGLE

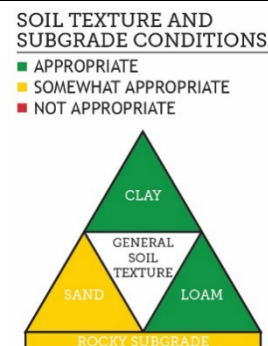

17. Erosion Logs (EL)



9. SWMP ADMINISTRATOR FOR DESIGN CRITERIA

- Ensure a maximum allowable tributary area of 0.25 acre with up to 150 feet of disturbed 3H:1V slope drains to the site per every 100 linear feet of Erosion Logs installed.
- Placement of Erosion Logs should meet the following maximum spacing requirements:

Flow Line Gradient	Maximum Check Dam Spacing based on Nominal Log Diameter (Feet)		
	8 to 9 Inches	12 Inches	18 to 20 Inches
0% to 2%	30	55	75
2% to 5%	25	40	55
5% to 10%	15	30	40
10% to 33%	10	15	20
33% to 50%	5	10	15

- The following are specific planning considerations for each Erosion Log type.
 - Erosion Log (Type 1) - Aspen wood excelsior contained in plastic netting. Plastic netting should not be used when regulatory permits prohibit their use or if there is a potential for plastic netting to endanger wildlife.
 - Erosion Log (Type 2) - Compost-wood blended material contained in geotextile bag. A longer-lasting control measure ideal for sites where filtering of hydrocarbons or dissolved metals are required.
 - Erosion Log (Type 3) - Aspen wood excelsior contained in natural fiber netting. A compostable (biodegradable) control measure ideal for locations where removing the logs might be labor intensive or cause damage to the existing vegetation.
 - Coir Roll - 100 percent coconut palm tree fiber contained in bristle coir netting considered a longer-lasting compostable (biodegradable) control measure used in stream bank restoration and wetland mitigation projects.

10. INSTALLATION CRITERIA

- Configure Erosion Logs perpendicular to concentrated flows and parallel to contour lines.
- Ensure Erosion Logs are trenched into the ground at least 2 to 3 inches to prevent riling and erosion beneath.
- Ensure wooden anchor stakes are embedded to a minimum depth of 12 inches and are placed at approximately 90 degrees from each other.
- When used for toe of slope protection measures, place Erosion or Coir Log 5 to 10 feet beyond the toe of the slope to provide storage capacity. Flare ends of Erosion Log upslope.
- When used as inlet protection measures, locate Erosion or Coir Logs at the edge of the concrete aprons or at the edge of the inlet grating if no concrete is present.

11. MAINTENANCE AND REMOVAL

- Visually inspect to ensure Erosion or Coir Log is installed properly and doesn't present erosion around it.
- If casting net is damaged, and the log becomes split, torn, or unraveled, remove and replace Log in-kind and dispose of damaged material properly.
- Remove sediment when sediment accumulates to half the height of the Log.
- Additional stakes are required if Log slumps or sags.
- Replace wooden stakes when broken or missing.
- When Erosion Log (Type 1) is no longer needed, remove and dispose of the log and accumulated sediment. Excelsior can be dispersed onsite with Engineer approval. All elements of the plastic netting must be picked up and disposed of at a landfill or recycling facility.

17. Erosion Logs (EL)



- When Erosion Log (Type 2) is no longer needed, remove and dispose of the log and accumulated sediment. With Engineer approval the compost-wood blended material can be dispersed onsite. All elements of the geotextile bag must be picked up and disposed of at a landfill or recycling facility.
- When Erosion Log (Type 3) and Coir Roll are no longer needed, dispose of the accumulated sediment; the Logs can remain onsite. All of the elements (entire Log and stakes) are compostable (biodegradable) and are not required to be removed for the permittee to terminate the stormwater construction permit.

17. Erosion Logs (EL)

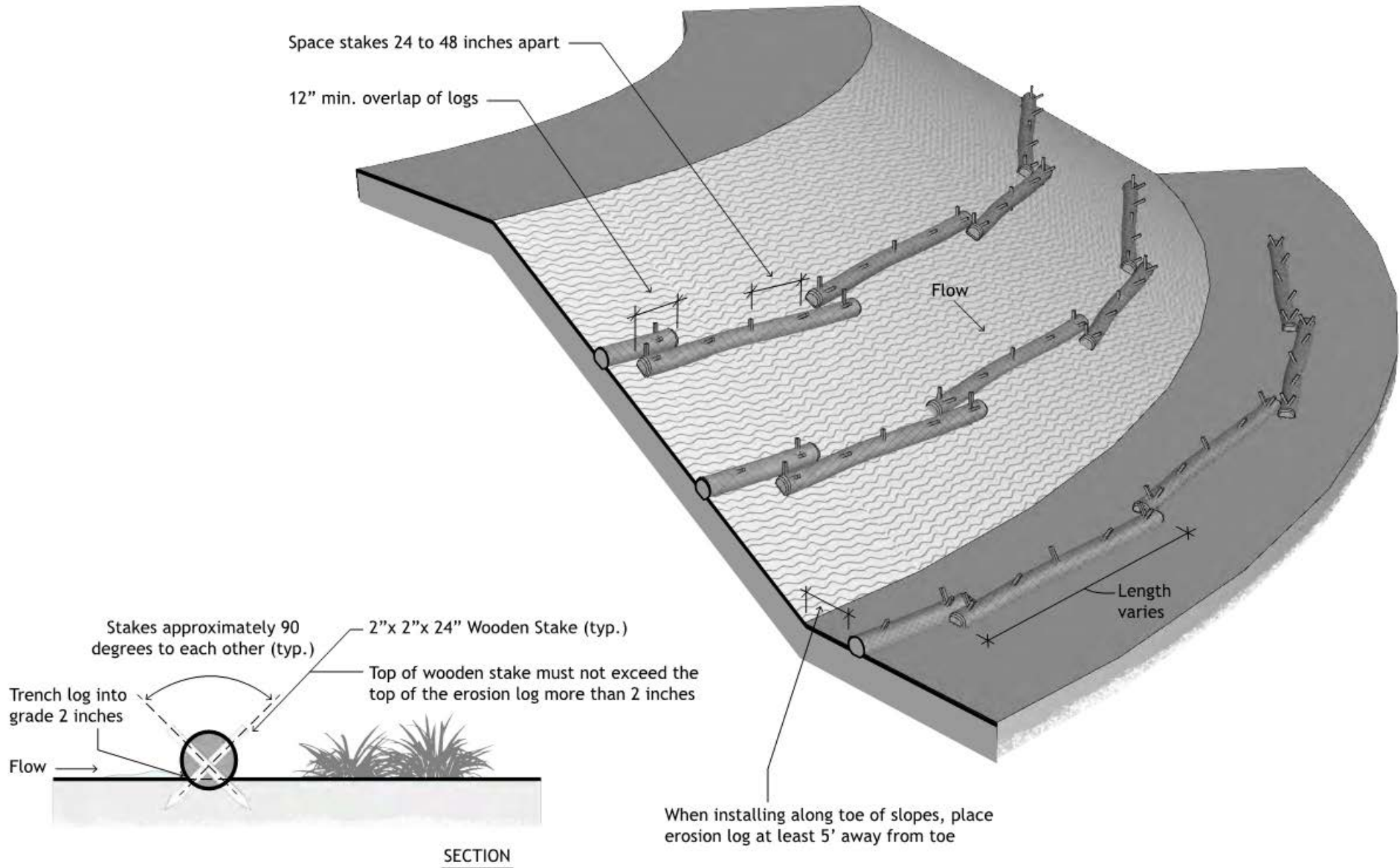

18. Sediment Trap (ST)

1. DESCRIPTION:

A Sediment Trap is a temporary control measure constructed by excavating a basin or building an earthen or rock berm lined with geotextile downgradient of a drainage basin. They are used to temporarily detain sediment-laden runoff and allowing sediment to settle out before releasing runoff onto a stabilized area.

2. CONTROL MEASURE USES

- Erosion Control
- Sediment Control
- Site/Materials Management

3. RELEVANT SPECIFICATION SECTIONS

[Section 208](#) - Erosion Control

- a) [208.04 \(g\)](#) - Materials
- b) [208.05 \(k\)](#) - Construction BMPs
- c) [208.11](#) - Method of Measurement
- d) [208.12](#) - Basis of Payment

4. RELEVANT M-STANDARD DETAILS

[M-208-1](#), Sheet 9 of 11 (Sediment Trap)

5. BASIS OF PAYMENT

Pay item	Description	Pay Unit
208-00033	Sediment Trap	EACH

6. APPLICATIONS

- Used in areas of concentrated flow or points for discharge during construction activities.
- May be used as a temporary control measure during construction in locations with relatively small drainage basins and that are accessible for easy cleanout.
- May be used in combination with other sediment control measures to increase capture capacity.



Sediment Trap downstream of rock check dams

7. LIMITATIONS

- Do not use within drainage ways that have high-flow volumes or velocities.
- This sediment control measure is not appropriate for drainage basins larger than 5 acres or for long-term sediment control uses.
- A large surface area is required to properly settle runoff sediment.
- This sediment control measure is most effective at removing medium- and coarse-grained particle size.

8. CONTROL MEASURE SOILS TRIANGLE

SOIL TEXTURE AND SUBGRADE CONDITIONS

- APPROPRIATE
- SOMEWHAT APPROPRIATE
- NOT APPROPRIATE

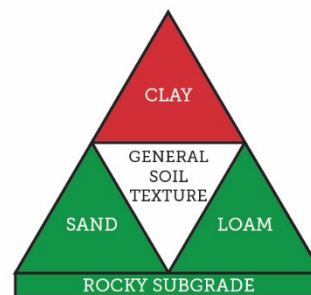

18. Sediment Trap (ST)



9. SWMP ADMINISTRATOR FOR DESIGN CRITERIA

- Divert runoff from undisturbed areas away from sediment traps.
- Provide the appropriate surface area and storage depth for these structures.
- Provide a minimum 20-foot setback from all structures and maintain an edge of road clear zone.
- The basin inlet shall be located to maximize travel distance to the basin outlet.
- Sediment Traps should be used on nearly level ground and the height of groundwater must be considered.
- Consider impact to downgradient areas from the weir overflow when locating Sediment Traps. Sediment Traps should not be used where weir failure could cause sediment deposition on travel lanes or damage to private property.

Sediment Trap Geometry:

- The recommended surface area measured at the elevation of the outlet weir can be calculated with the following equations:

Soils Type	Minimum Required Surface Area (square feet)
Coarse (Loamy Sand, Sandy Loam and Sand)	Area = 625 x (Drainage Basin Area ^a)
Medium (Loam, Silt Loam and Silt)	Area = 1560 x (Drainage Basin Area ^a)

^a Drainage basin area in acres

- Ensure a minimum capacity of 1,800 cubic feet per acre of drainage basin treated is provided measured from the Sediment Trap invert to the outlet weir crest elevation (wet storage depth).

Sediment Trap Embankment:

- The Sediment Trap embankment must not exceed 5 feet in height measured between the downgradient toe of the embankment to the top of the embankment.

Sediment Trap Outlet Structure:

- The outlet size depends on the drainage basin area; recommended weir lengths are listed in this table:

Drainage Basin Area (Acres)	1	2	3	4	5
Weir Length (Feet)	4	6	8	10	12

- The sediment trap must be designed to properly pass the 10-year flood event without overtopping the basin.
- Use a minimum of 12-inch D50 rock for the outlet weir structure and spillway.
- As an alternative, flows may be released using an outlet pipe leading to a riprap dissipation pad.

Other Design Considerations

- Confirm that outflows have nonerosive velocities before reaching the existing ground; if velocities are higher; provide a riprap dissipation pad at the end of the outlet spillway.
- The final Sediment Trap design must be approved by the Engineer working directly with the Erosion Control Supervisor or Regional Environmental Staff.

18. Sediment Trap (ST)



10. INSTALLATION CRITERIA

- Install Sediment Traps prior to starting disturbance activities in locations receiving upgradient flows.
- The area under the embankment shall be cleared, grubbed, and stripped of any vegetation or roots prior to installation.
- Direct Sediment Trap outflows to a moderately flat vegetated or stabilized area.
- Additional measures should be used if turbidity leaving the site served by this practice is an issue

11. MAINTENANCE AND REMOVAL

- Inspect Sediment Traps before, during, and after every storm event and at regular intervals for proper functioning, presence of any embankment damage, or damage to the outlet structure.
- Repair any damage to structure and remove any outlet obstructions immediately after inspection.
- If captured runoff has not completely infiltrated within 72 hours, Sediment Trap must be dewatered.
- When sediment volume has reached half of the wet storage depth (bottom to top of weir), remove and dispose of accumulated sediment.
- Remove Sediment Trap only when the disturbed area upstream has been fully stabilized; sediment and rock may be dispersed onsite at locations approved by the Engineer. All other materials must be removed from the site and disposed of at a landfill or recycling facility.
- The area disturbed by this control measure should be covered with topsoil and stabilized.

18. Sediment Trap (ST)

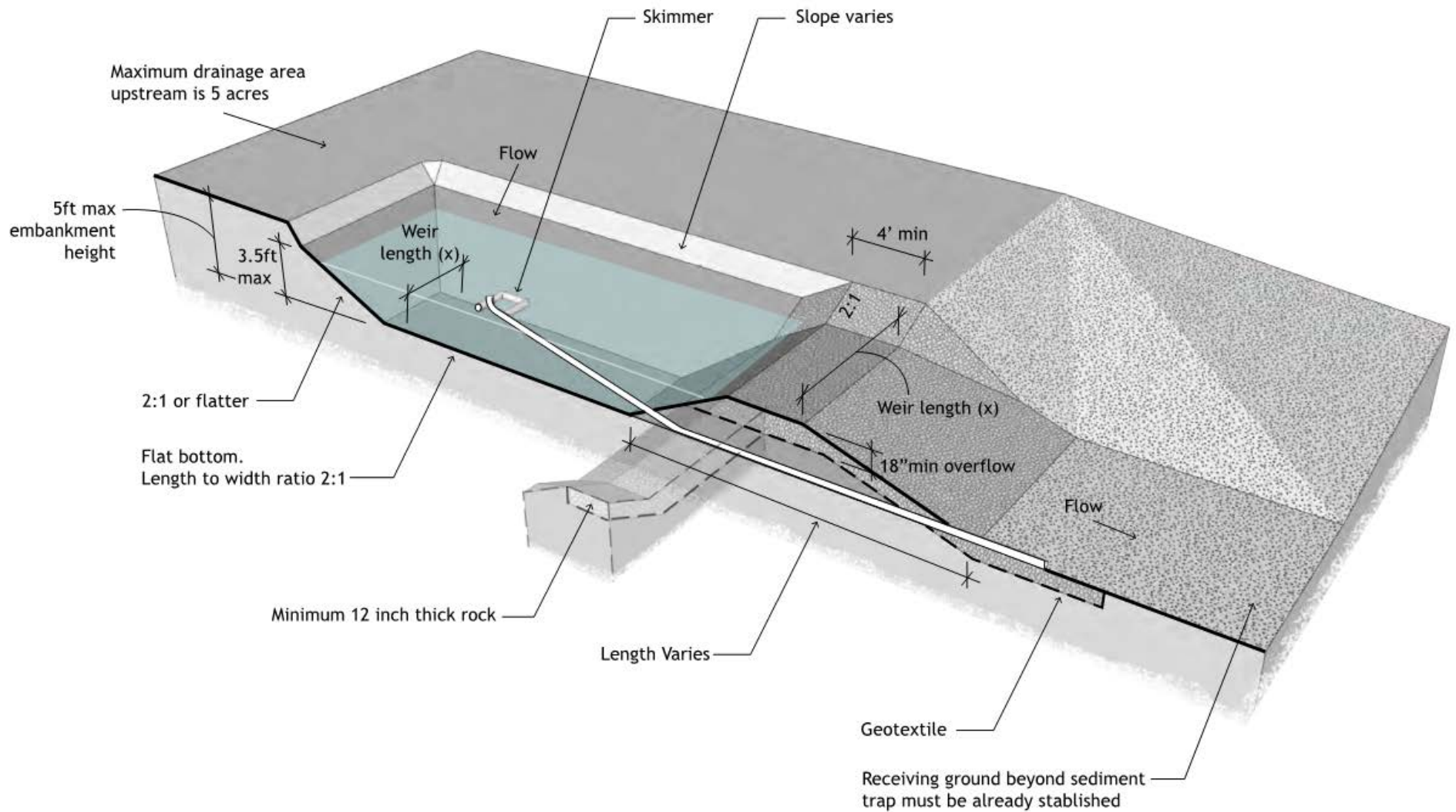

19. Silt Dikes (SD)



1. DESCRIPTION:

Silt dikes are pre-manufactured flexible temporary control measures that will fully rebound when driven over by heavy equipment. Material consists of outer geotextile fabric covering closed cell urethane or polyethylene foam core. The geotextile fabric aprons extend beyond the foam core on both sides. These versatile control measures can be used for sediment retention and flow velocity reduction.



Silt Dike - Credits to South Dakota Department of Transportation

2. CONTROL MEASURE USES

- Erosion Control
- Sediment Control
- Site/Materials Management

3. RELEVANT SPECIFICATION SECTIONS

[Section 208](#) - Erosion Control

- a) **208.04.(j)** - Materials
- b) **208.05.(m)** - Construction of Control Measures
- c) **208.11** - Method of Measurement
- d) **208.12** - Basis of Payment

4. RELEVANT M-STANDARD DETAILS

No standard detail exists, project will require a project special detail.

5. BASIS OF PAYMENT

Pay item	Description	Pay Unit
208-00001	Silt Dike	LF

6. APPLICATIONS

- Around temporary stockpiles on hard surfaces.
- Perimeter edge protection for projects where disturbed soil and had surface meet.
- Used on either soil or hard surfaces.
- To reduce flow velocity along haul roads or in batch plants and material staging areas.
- At site access points.

7. LIMITATIONS

- Must be anchored with adhesive, staples, nails, or other approved system.
- Proper installation of geotextile aprons is crucial for proper structure performance.
- Requires continuous monitoring for erosion and sediment deposition.
- Limited sediment storage because of a vertical height of only 5 inches after installation.
- Does not filter hydrocarbons or dissolved metals.

8. CONTROL MEASURE SOILS TRIANGLE

SOIL TEXTURE AND SUBGRADE CONDITIONS

- APPROPRIATE
- SOMEWHAT APPROPRIATE
- NOT APPROPRIATE

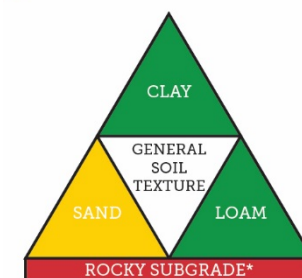

*Only install when level base can be provided

19. Silt Dikes (SD)



9. SWMP ADMINISTRATOR FOR DESIGN CRITERIA

- Lightweight synthetic alternatives to Erosion Logs and straw bale barriers that can survive being driven over by construction traffic (tires and tracks).
- Avoid using in areas where vehicles will be turning on top of geotextile.
- Control measure that is generally more durable for longer-term projects and can be reused.
- Control measure may be installed on either soil or hard surfaces, with attachment in accordance with Subsection 208.02.
- Ships compressed, which allows for more product on each truck delivery for remote projects.

10. INSTALLATION CRITERIA

- Prior to installation on soil surfaces, prepare grade by removing materials greater than 2 inches in diameter and debris to provide a relatively smooth surface.
- Prior to installation on hard surfaces, prepare pavement by removing all loose material from under the area covered by the aprons.
- When multiple Silt Dike units are used, ensure geotextile fabric sleeves are correctly used to interlock segments (geotextile overlap).
- Do not pierce the foam core of the barrier with stakes or nails.

11. MAINTENANCE AND REMOVAL

- Visually inspect to ensure Silt Dike is installed properly and doesn't cause erosion around it.
- Foam cores may flattened with repeated traffic, and may require additional maintenance to re-form to original height.
- Repair or replace any damaged parts (sections of torn geotextile). Immediately repair and stabilize as needed to ensure proper anchorage.
- Remove sediment as soon as it accumulates to half the height of the Silt Dike.
- Re-attach any flexible sediment barriers that detach from the pavement.
- Any disturbed areas must be covered with topsoil, seeded, and mulched or otherwise stabilized in a manner approved by the Engineer working directly with the Regional Environmental Staff.
- Intact functional Silt Dikes can be reused; all elements (geotextile, stakes, nails, and foam) of damaged Silt Dikes must be removed from project site and disposed of at a landfill or recycling facility.

19. Silt Dike (SD)

Geosynthetic fabric apron. Extend Apron at least 2ft to each side of silt dike

Point A: Point "A" shall be higher than point "B" to ensure that water flows over the dike and not around the edges

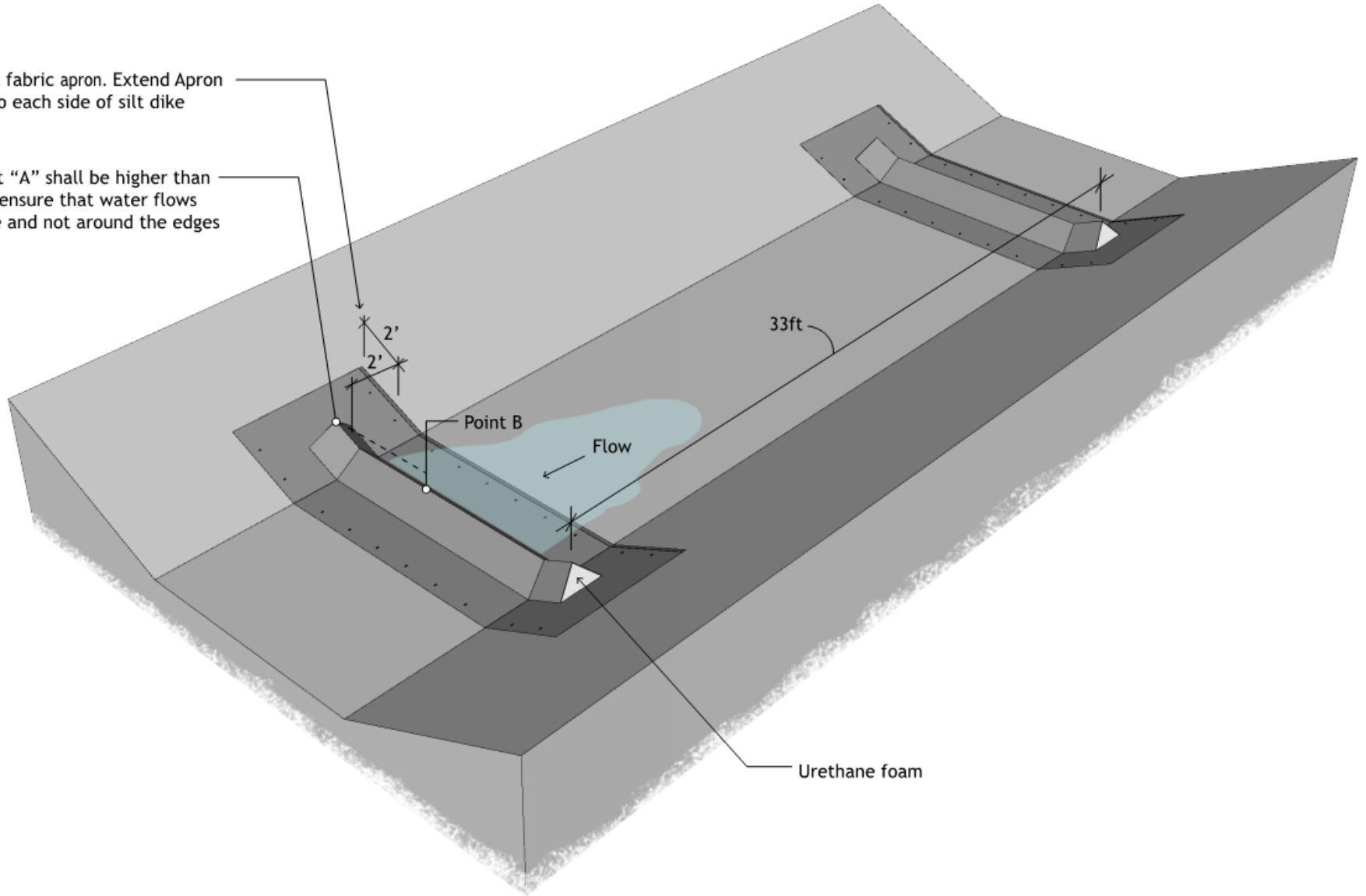

20. Silt Fence (SF)



1. DESCRIPTION:

Silt Fence is a temporary, entrenched sediment barrier made from woven geotextile fabric (in some cases with wire backing) and stretched across supporting wooden posts. It is used to intercept stormwater runoff containing sediment loads. Silt Fence is intended to allow sediment in surface runoff to settle before runoff leaves the project site.

2. CONTROL MEASURE USES

- Erosion Control
- Sediment Control
- Site/Materials Management

3. RELEVANT SPECIFICATION SECTIONS

[Section 208](#) - Erosion Control

- a) [208.02.\(b\)](#) - Materials
- b) [208.05.\(c\)](#) - Construction of Control Measures
- c) [208.11](#) - Method of Measurement
- d) [208.12](#) - Basis of Payment

4. RELEVANT M-STANDARD DETAILS

[M-208-1](#), Sheet 3 of 11 (Toe of Slope Protection Applications)

[M-208-1](#), Sheet 8 of 11 (Silt Fence Applications)

5. BASIS OF PAYMENT

Pay item	Description	Pay Unit
208-00020	Silt Fence	LF
208-00021	Silt Fence (Reinforced)	LF

6. APPLICATIONS

- Downgradient of a disturbed area
- Along the perimeter of receiving waters (e.g. streams, ponds, and wetlands)
- Along the perimeter of a construction site (for example, staging area, and stabilized construction roads)
- Around temporary stockpiles
- At the toe of fill of exposed and erodible soils.

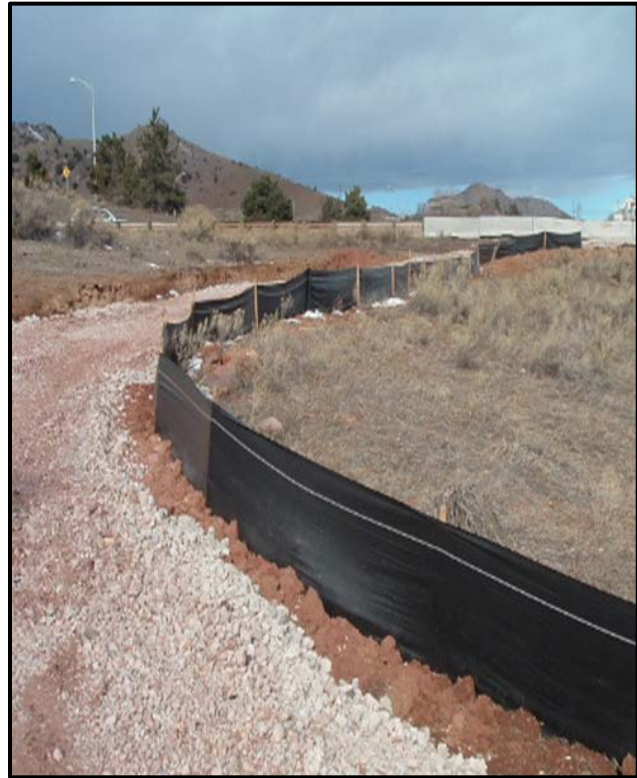

Silt fence along perimeter of stabilized construction road

7. LIMITATIONS

- Not for intercepting concentrated flows (streams, channels, drainage paths).
- Limit use to drainage basin areas of 0.25 acres or less.
- Not suitable for mid-slope protection on slopes steeper than 4H:1V.
- Not suitable as flow diversion.
- Not suitable for areas where continuous ponding occurs.

8. CONTROL MEASURE SOILS TRIANGLE

SOIL TEXTURE AND SUBGRADE CONDITIONS

- APPROPRIATE
- SOMEWHAT APPROPRIATE
- NOT APPROPRIATE

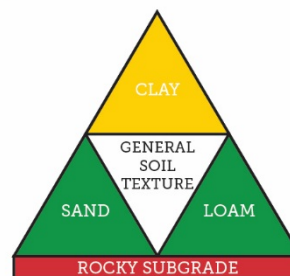

20. Silt Fence (SF)



9. SWMP ADMINISTRATOR FOR DESIGN CRITERIA

- Designer may use standard or reinforced Silt Fence with wire backing based on site conditions.
- Limit tributary drainage area to less than 0.25 acre of disturbed area for every 100 linear feet of installed Silt Fence.
- Limit disturbed slope length to 150 feet per 100 linear feet of Silt Fence installed.
- Ensure flows reaching Silt Fence are lower than 0.5 cfs per linear foot of Silt Fence installed.
- Ensure elevation of Silt Fence base does not vary more than $(1/3 \times \text{height})$ of Silt Fence installed.
- When base elevation of Silt Fence varies more than $(1/3 \times \text{height})$ of Silt Fence installed, offset next row of Silt Fence and ensure an overlap between rows of at least 10 linear feet.
- Limit installed run distance to 500 linear feet.
- Protects drainageways from upland disturbance resulting from construction.
- May be installed in high winds areas or on slopes greater than 2H:1V, prior in consultation with SWMP Reviewer.
- Use reinforced Silt Fence when areas of rock or soil dislodging are frequent.

10. INSTALLATION CRITERIA

- Silt Fence is most effective when installed in relatively level terrain, or parallel to a contour, on slopes that shed sheet flow.
- For Silt Fence at the toe of a slope, place at least 5 feet away from toe of slope to allow for maintenance access.
- Anchor the bottom portion of the Silt Fence in a 6-inch deep by 6-inch wide trench and compact.
- Where installation along contour is not possible, construct a J-hook to ensure no concentrated flow paths are created along the installed Silt Fence.

11. MAINTENANCE AND REMOVAL

- Visually inspect installed Silt Fence frequently; immediately repair any holes in geofabric, slumping of the fence, and undercut areas.
- Inspect installed Silt Fence whenever rainfall is forecast and after every storm event.
- Damaged Silt Fence material shall be replaced, removed from construction site, and disposed of appropriately during the contracted construction period.
 - Silt Fence has a lifespan between 5 and 8 months; projects with longer duration might need to partially or fully replace installed Silt Fence one or more times during construction.
 - Repair or replace any damaged length of Silt Fence resulting from snow removal operations near roadway construction areas.
- After construction activities have concluded and with prior authorization from the Erosion Control Supervisor or Regional Environmental Staff, have contractor remove installed stakes and fabric both above and below ground, and stabilize ground (returning it to pre-project conditions) by filling and compacting post holes, removing sediment accumulation, and blending the disturbed area to match existing surroundings.
- Only remove silt fence when construction activities upgradient are complete and replacement control measure(s), such as Erosion Bales or Erosion logs have been placed, and with Erosion Control Supervisor or Regional Environmental Staff approval.

20. SILT FENCE (SF)

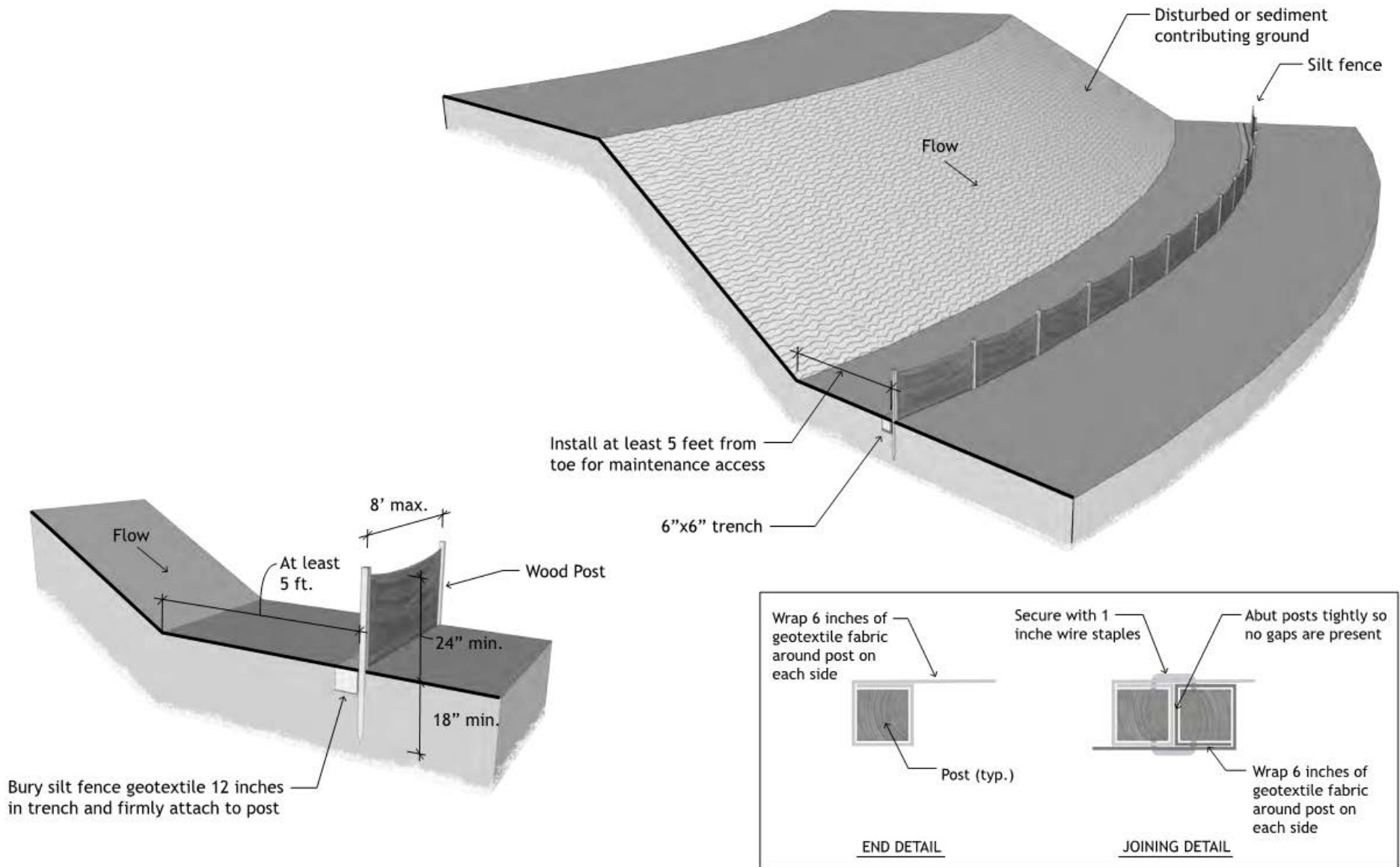

21. Storm Drain Inlet Protection (IP)

1. DESCRIPTION:

Storm Drain Inlet Protection Devices are temporary control measures consisting of permeable geotextile fabrics installed below the inlet grate or configured as an inlet grate cover. Primarily used in paved areas to protect drop inlets or curb inlets, they are used to filter runoff and remove coarse sediment and debris before runoff enters a storm drainage system.

2. CONTROL MEASURE USES

- Erosion Control
- Sediment Control
- Site/Materials Management

3. RELEVANT SPECIFICATION SECTIONS

[Section 208](#) - Erosion Control

- a) [208.02.\(n\)](#) - Materials
- b) [208.05.\(i\)](#) - Construction of Control Measures
- c) [208.11](#) - Method of Measurement
- d) [208.12](#) - Basis of Payment

4. RELEVANT M-STANDARD DETAILS

[M-208-1](#), Sheet 5 of 11 (Storm Drain Inlet Protection Types)

5. BASIS OF PAYMENT

Pay Item	Description	Pay Unit
208-00053	Storm Drain Inlet Protection (Type II) (84-Inch)	EACH
208-00054	Storm Drain Inlet Protection (Type II)	EACH
208-00055	Rigid Inlet Protection Device	EACH
208-00056	Storm Drain Inlet Protection (Type III)	EACH
208-00057	Storm Drain Inlet Protection (Type I) (144 Inch)	EACH
208-00058	Storm Drain Inlet Protection (Type I) (204 Inch)	EACH



Storm Drain Inlet Protection

6. APPLICATIONS

- Use where sediment-laden flows will potentially enter existing storm inlets.
- Use near construction areas that have not been stabilized.
- Use near construction entrance/exit points where vehicles may track sediment towards existing storm inlets

7. LIMITATIONS

- May pond water and represent an obstacle for pedestrian and vehicle traffic.
- In all situations, Inlet Protection Devices will require additional upstream control measures for sediment capture.
- Frequent maintenance is required to ensure proper control measure and Inlet Protection structure functioning.

8. CONTROL MEASURE SOILS TRIANGLE

SOIL TEXTURE AND SUBGRADE CONDITIONS

- APPROPRIATE
- SOMEWHAT APPROPRIATE
- NOT APPROPRIATE

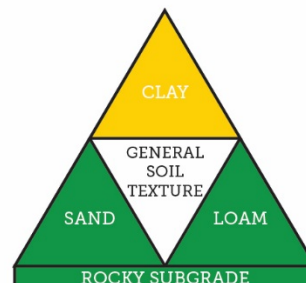

21. Storm Drain Inlet Protection (IP)

9. SWMP ADMINISTRATOR FOR DESIGN CRITERIA

- Specify inlet protection on all existing inlets on the Initial SWMP site maps. Use Inlet Protection to control sediment and other construction material from entering the catch basin and discharging directly to State Waters.
- Specify inlet protection on all proposed inlets on the Interim SWMP Site Maps to be phased in as the catch basin and grate is installed.
- Because of safety concerns, Storm Drain Inlet Types 1, 2 and 3 should be used when traffic flow is not within 3 feet of the inlet or other situations where aggregate bags may cause a safety concern for traveling public (for example, bike lanes or pedestrian crossings).
- The geotextile fabric material is required to have a minimum flow rate.
- Potentially hazardous conditions from water ponding on pavement surface should be considered.
- Verify size and configuration of existing inlets to ensure the inlets were installed according to the requirements of CDOT's M-604 standards.
- The following control measure may be used as inlet protection for paved areas: Aggregate Bags.
- The following control measures may be used as inlet protection for unpaved areas: Erosion Logs, Silt Fence (Reinforced), and Erosion Bales.
- When approved, the following design considerations apply:

Temporary Control Measure	Design Considerations
Aggregate Bag	<ul style="list-style-type: none"> • Runoff flow must be below 0.5 cfs • Drainage area below 1 acre
Erosion Logs	<ul style="list-style-type: none"> • Must be able to anchor logs • Drainage area below 1 acre
Erosion Bales	<ul style="list-style-type: none"> • Must be able to anchor bales • Drainage Area below 1 acre
Silt Fence	<ul style="list-style-type: none"> • Runoff must be sheet flowing and below 0.5 cfs • Low sediment capture • Drainage area below 1 acre

- Suggested guidelines for the use of Storm Drain Inlet Protection Types are listed below:

	Storm Drain Inlet Protection Type			
	Type I	Type II	Type III	Rigid
CDOT Standard Inlet Types (M-604 Standard Plans) Application	CDOT Type R	CDOT Combination Inlet	CDOT Vane Grate	Inlet Type C, D, and 13

10. INSTALLATION CRITERIA

- When installing nonstandard (project special provision) prefabricated Storm Drain Inlet Protection Devices, follow manufactures material standards and specifications.
- When using other control measures as Inlet Protection Devices, follow installation criteria previously outlined for each control measure.
- Follow installation procedures outlined in the CDOT M-208-1 Standard Details.
- For new inlets, the Inlet Protection Devices should be installed as soon as the catch basin and grate are installed.

21. Storm Drain Inlet Protection (IP)

11. MAINTENANCE AND REMOVAL

- Visually inspect at regular intervals, and before and after every storm event to ensure Inlet Protection Device is installed properly and erosion has not presented around it.
- Inspect inlet structures at regular intervals and after every storm event for bypassed sediment materials that may accumulate inside the structure.
- Move and secure Inlet Protection Devices as needed to achieve optimum performance.
- Inlet Protection Devices that are damaged must be replaced immediately.
- Remove any sediment upstream of the Inlet Protection Device location and sediment that may have bypassed the Inlet Protection Device immediately upon inspection completion.
- When using other control measures as temporary inlet protection devices, follow the maintenance and removal recommendations provided for those control measures.
- Inlet Protection Devices must be removed after final stabilization of the construction site has been completed. Most prefabricated Inlet Protection Devices can be recycled and reused after properly washing the device. Ensure no sediment is released into the Inlet Structure.
- Other control measures must be disposed of following the recommendations listed in their corresponding fact sheets.
- All maintenance must be done without entering the catch basins (vault) structure because of safety concerns and confined space requirements.

22. Temporary Slope Breaks (TSB)



1. DESCRIPTION:

Temporary Slope Breaks are practices aimed to create breaks to effectively shorten the uninterrupted flow path length of surface runoff on slopes steeper than 4H:1V. As sheet flow runoff moves down a long slope, the potential for erosion increases. Typical practices include installation of rolled erosion control measures or the application of grading techniques to create relatively flat terraces separating steep slope segments. Interceptor ditches are ditches constructed at top of slope to divert run-on water from above drainage basin from flowing over slope. The temp or permanent ditch conveys water to a Temporary Slope Drain or permanent embankment protector. Erosion Logs and Silt Dikes are typically used to construct this control measure.



Use of Erosion Logs as temporary slope breaks on disturbed slopes

2. CONTROL MEASURE USES

- Erosion Control
- Sediment Control
- Site/Materials Management

3. RELEVANT SPECIFICATION SECTIONS

No standard specification exists, project will require a Project Special Provision Specification.

4. RELEVANT M-STANDARD DETAILS

No standard detail exists, project will require a project special detail.

5. BASIS OF PAYMENT

Section not applicable for this control measure.

6. APPLICATIONS

- Used to temporarily stabilize disturbed steep-sloped areas, minimizing potential for wind and water erosion.
- Employ additional control measure besides Temporary Slope Breaks, to achieve sediment capture goals.

7. LIMITATIONS

- Must be used in combination with other erosion and sediment control measures such as Temporary Seeding, Mulching, or installation of Erosion Logs to be effective.
- Special staking may be required on slopes to ensure proper anchoring and good stabilization.
- Use below the ordinary high-water mark or where maximum grading upslope is steeper than 1H:1V is not allowed.

8. CONTROL MEASURE SOILS TRIANGLE

SOIL TEXTURE AND SUBGRADE CONDITIONS

- APPROPRIATE
- SOMEWHAT APPROPRIATE
- NOT APPROPRIATE

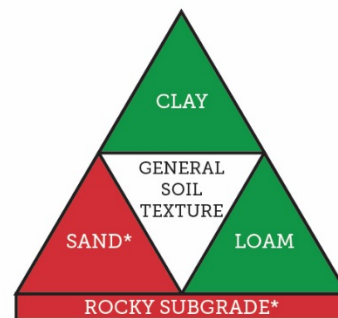

22. Temporary Slope Breaks (TSB)



9. SWMP ADMINISTRATOR FOR DESIGN CRITERIA

- When installing Erosion Logs, refer to the appropriate fact sheet for design criteria.
- When using Erosion Logs or Silt Dikes, the ends should be turned upslope 3 linear feet at a minimum.
- Erosion Logs may be used to create Temporary Slope Breaks. Recommended spacing should approximately follow the parameters in this table:

Slope Type	Slope (H:V)	Slope Length (feet)
Cut Slope	2:1	15
	3:1	25
	4:1	30
Fill Slope	2:1	10
	3:1	20
	4:1	25

- When applying terrace grading practices to provide slope breaks, consideration must be given to the following factors:
 - Determine if the area contains cut or fill slopes. Typically, fill slopes are more unstable as a result of their disturbed and uncompacted nature and will require breaks more often.
 - Determine erosion potential using Revised Universal Soils Loss Equation (RUSLE 2) as.
 - Additional soil retention measures may be needed for greater than 2H:1V), including the installation of Soil Retention Blankets, gabions, temporary retaining walls, or other means of temporary soil retention.
 - Include adequate outlets that prevent erosion.
 - Graded slope breaks should be able to handle the peak runoff expected from a 2-year, 24 hour design storm without overtopping.
 - Constructing Temporary Diversions will redirect slope surface runoff. The Engineer must design proper drainage features along the slope breaks while they are used, and these may be recommending a 2 to 3 percent longitudinal grade along the terraces or providing Temporary Slope Drains at low spots to convey runoff.

10. INSTALLATION CRITERIA

- Ensure that the constructed Temporary Slope Breaks are built parallel to the contours. For short runs the longitudinal grade behind the Temporary Slope Break should never exceed 5%.
- Prior to constructing grading terraces, verify that suitable outlets are shown on the SWMP.
- Once Temporary Slope Drains are installed, approved Surface Roughening & Vehicle Tracking is not required at the end of each day.
- See fact sheet No. 16 (Erosion Logs) and fact sheet No. 19 (Silt Dike) for additional installation criteria.

11. MAINTENANCE AND REMOVAL

- Visually inspect with regular frequency for the presence of rills, erosion, sediment accumulation, and presence of obstructions along the terraced areas or rolled erosion control measures.
- Visually inspect slope breaks before and after every storm event to ensure proper placement and functioning of devices.
- Rills and erosion spots must be repaired immediately upon inspection.
- Maintain and remove primary control measures as indicated in the appropriate sections of this chapter.

23. Vehicle Tracking Control (VTP)



1. DESCRIPTION:

Vehicle Tracking Control is a temporary control measure that consists of stabilized layer of aggregate or a pre-fabricated structure that is used to minimize tracking of sediments from the construction site (exposed soil) to paved road surface. Related to vehicle tracking, CDPHE recognizes that fine grains (staining) may remain visible on the surfaces of offsite streets, other paved areas, and sidewalks after implemented sediment removal practices have been implemented.

2. CONTROL MEASURE USES

- Erosion Control
- Sediment Control
- Site/Materials Management

3. RELEVANT SPECIFICATION SECTIONS

[Section 208](#) - Erosion Control

- a) **208.02** - Materials
- b) **208.02 (I)** - Materials - Vehicle Tracking Pad
- c) **208.05.(o)** - Construction BMPS - Vehicle Tracking Pad
- d) **208.11** - Method of Measurement
- e) **208.12** - Basis of Payment

4. RELEVANT M-STANDARD DETAILS

[M-208-1](#), Sheet 1 of 11 (Vehicle Tracking Pad)

5. BASIS OF PAYMENT

Pay Item	Description	Pay Unit
208-00070	Vehicle Tracking Pad	EACH
208-00075	Pre-Fabricated Vehicle Tracking Pad (Type 1)	EACH
208-00175	Pre-Fabricated Vehicle Tracking Pad (Type 2)	EACH
208-00071 ^a	Maintenance Aggregate (Vehicle Tracking Pad)	CY

^a Pay item is included for anticipated maintenance of Vehicle Tracking Pads based on the service life of the control measure in the field.



Vehicle tracking pad at entrance of construction site

6. APPLICATIONS

- Used at construction site entrance and exit locations.
- Used during wet weather periods when tracking of dirt is increased.

7. LIMITATIONS

- Additional Control Measures may be needed when Vehicle Tracking Control is graded towards paved surfaces.
- When installation of aggregate Vehicle Tracking Pad is not feasible, consider using Pre-fabricated Vehicle Tracking Pads.

8. CONTROL MEASURE SOILS TRIANGLE

SOIL TEXTURE AND SUBGRADE CONDITIONS

- APPROPRIATE
- SOMEWHAT APPROPRIATE
- NOT APPROPRIATE

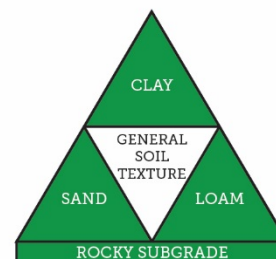

23. Vehicle Tracking Control (VTP)



9. SWMP ADMINISTRATOR FOR DESIGN CRITERIA

- Consideration of site grades, sight distances, and curves on public roads when selecting a location for Vehicle Tracking Pads.
- Aggregate-based Vehicle Tracking Pad must be at least 12 feet wide and 70 feet long.
- Pre-fabricated Vehicle Tracking Pad must be at least 12 feet wide and 35 feet long.
- If runoff flow paths are directed towards the Vehicle Tracking Pad, use Temporary Berms, Silt Dikes, or other runoff routing control measures to divert flows to a different location.
- Additional site management control measures (Silt Fence and plastic fence) should be designed to direct construction traffic to the egress point with the Vehicle Tracking Pad.

10. INSTALLATION CRITERIA

- To accommodate the traffic between pre-fabricated Vehicle Tracking Pad and paved surface, and the turning radius of construction vehicles anticipated on site; the specified vehicle tracking aggregate must be used.
- A geotextile separation layer and aggregate base course may be required to stop rutting under the pre-fabricated Vehicle Tracking Pads or areas where construction vehicles mount or dismount.
- Entrance/exit area must be excavated 6 inches, and Class 2 geotextile fabric must be installed and covered by a 6-inch aggregate layer. Aggregate must meet the gradation requirements listed in Section 208.02.(l)
- When using Pre-fabricated Vehicle Tracking Pads, follow manufacturer's specifications for installation. Ensure a clean, even surface is provided prior to installation and that the system is properly anchored prior to use.
- Install prior to any traffic leaving the site.
- **Additional control measures should be incorporated to prevent sediment on the Vehicle Tracking Pad from leaving the site.**

11. MAINTENANCE AND REMOVAL

- Visually inspect to ensure Vehicle Tracking Pad is installed and anchored properly.
- Daily cleanup may be required; if dirt is tracked onto the street it must be cleaned up within 24 hours (reference the Street Sweeping fact sheet [No. 35] for more information).
- Using Pre-fabricated Tracking will require more frequent maintenance than aggregate-based Vehicle Tracking Pads.
- Site Signage may be used to indicate and direct traffic to construction site exit locations with Vehicle Tracking Control.
- Vehicle Tracking Pads should only be removed when site is stabilized and the potential for vehicle tracking to occur does not exist. Aggregate from tracking pad may be washed and dispersed onsite at locations approved by the Engineer; Pre-fabricated Tracking Pads may be washed offsite, recycled, and reused.
- Some sites may require wheel washing stations, refer to the Vehicle and Equipment Management fact sheet (No. 37) for more information.

27. Concrete Waste Management (CWM)



1. DESCRIPTION:

Concrete Washout Structures are designed to promote the hardening of concrete along with infiltration and evaporation of excess liquid from the washout of concrete trucks and concrete-coated equipment. They are required for the high-pH and cementitious residue from cutting, coring, grinding, grooving, and hydro-concrete demolition. These structures are used to collect and contain the washout and solids from entering storm drains, receiving waters, or the hard surfaces within CDOT highway right-of-way.



Concrete washout structure

2. CONTROL MEASURE USES

- Erosion Control
- Sediment Control
- Site/Materials Management
- Waste Management

3. RELEVANT SPECIFICATION SECTIONS

[Section 208](#) - Erosion Control

a) [208.02.\(e\)/\(f\)](#) - Materials

b) [208.05.\(n\)](#) - Construction BMPS

[Section 203](#) - *Excavation and Embankment*

a) [203.03](#) - *Embankment Material*

[Section 107](#) - *Embankment Material*

a) [107.25*](#) - *Water Quality Control*

*Also see [Revision of Section 107](#) - *Water Quality Control*

4. RELEVANT M-STANDARD DETAILS

[M-208-1](#), Sheet 1 of 11 (Concrete Washout Structure)

5. BASIS OF PAYMENT

Pay item	Description	Pay Unit
208-00045	Concrete washout structure	EA
208-00046	Pre-fabricated concrete washout structure (type 1)	EA
208-00146	Pre-fabricated concrete washout structure (type 2)	EA

6. APPLICATIONS

- Slurries containing Portland cement concrete or asphalt concrete are generated. This can be generated from saw-cutting, coring, grinding, grooving, and hydro concrete demolition.
- Mortar-mixing areas exist on the construction site.
- Testing of concrete or mortar on the construction site.

7. LIMITATIONS

Section not applicable for this Management Strategy.

8. APPROVED PRODUCTS LIST

Refer to: <https://www.codot.gov/business/apl>

27. Concrete Waste Management (CWM)



9. SWMP ADMINISTRATOR FOR DESIGN CRITERIA

- Structures should be located a minimum of 50 horizontal feet away from State Waters.
- Washout structures should be located on the site based on safe access by the appropriate vehicles.
- Select concrete washout facilities sufficient to contain all liquid and concrete waste generated by washout operations. Consider the project location and anticipated construction phasing when selecting concrete washout strategy.
- Specify approximately one belowgrade concrete structure for every 1,200 cubic yards of concrete anticipated for the project.
- Specify approximately one Pre-fabricated Concrete Washout Structure (Type 1) for approximately every 180 cubic yards of concrete anticipated for the project.
- Specify approximately one Pre-fabricated Concrete Washout Structure (Type 2) for approximately every 20 cubic yards of concrete anticipated for the project.

10. INSTALLATION CRITERIA

Concrete Washout

- For below grade Concrete Washout Structure:
 - Embankment required for the concrete washout structure may be excavated material, provided that this material meets the requirements of CDOT Specifications Section 203 for embankment.
 - The bottom of the excavation must be at least 5 vertical feet above groundwater. If it is not, it must be lined with an impermeable synthetic liner that meets the requirements of Table 208-5.
 - A temporary berm (2:1) should surround the concrete washout area.
 - Freeboard capacity should be included in the structure design to reasonably ensure the structure will not overtop during or because of a precipitation event.
- For pre-fabricated Concrete Washout Structure:
- Install structure in accordance with manufacturer's specifications and recommendations.

11. PROCEDURES

Concrete Demolition Waste

- Stockpile concrete demolition waste away from drainage structures and waterways to prevent dust and debris from entering State Waters.
- Dispose of concrete demolition waste per applicable solid waste regulations.

Concrete Slurry Waste Management and Disposal

- Portland cement concrete and asphalt concrete should not be allowed to enter storm drainage systems or other watercourses.
- Concrete residual from saw-cutting, coring, and grinding operations should be picked up by a vacuum device and should not be left on the surface of the pavement.
- Slurry residual should be stored in an onsite Concrete Washout Structure.
- Return unused or leftover concrete to the originating batch plant for recycling when available.

General Requirements for Temporary Concrete Washout Structures

- Concrete washout and pre-fabricated concrete washout structures should conform to the following requirements:
 - The structure should meet or exceed the dimensions and volumes shown on the plans and be used in accordance with manufacturer's recommendations. The structure should sufficiently contain all washout water and be accessible to appropriate construction equipment.

27. Concrete Waste Management (CWM)



- A minimum of 10 days prior to the start of the construction activity, the Contractor shall submit in writing a Method Statement for Containing Pollutant Byproducts' to the Engineer for approval. The Method Statement should contain the proposed practices to prevent concrete material and washwater from entering State Waters.
- The structure should be completed and ready for use prior to concrete placement operations and should remain in place until all concrete work for the project is completed.
- The site should be located a minimum of 50 horizontal feet from drainageways and watercourses and should meet all requirements for containment and disposal as defined in Standard Specifications Section 107.25. Do not place concrete washout areas in low areas or ditches.
- Belowgrade washout structures should be delineated with orange plastic fence. All concrete washout structures shall be signed as "Concrete Washout." If the washout areas are not being used regularly, consider posting additional signage, relocating the facilities to more convenient locations, or providing training to workers and contractors.
- Solvents, flocculants, and acid should not be added to the washwater.

Concrete Washout Structure

- Stormwater should not carry wastes from washout and disposal locations.
- The Contractor should prevent tracking of washout material out of the washout structure.
- The structure should be surrounded on three sides by a compacted berm.
- Plastic lining material should be free of holes, tears, or other defects.
- Soil base should be prepared free of rocks or other debris that may cause tears or holes in the plastic lining material.

Pre-fabricated Concrete Structure

- A pre-fabricated concrete washout structure consists of a watertight container designed to contain liquid and solid waste from concrete washout. This structure should only be used when specified in the Contract.
- A pre-fabricated concrete structure should meet these additional requirements:
 - Pre-fabricated structures cannot be moved when they contain liquid, unless otherwise approved.
 - Washout areas should be checked and maintained as required. Onsite permanent disposal of concrete washout waste is not allowed.

12. MAINTENANCE REMOVAL

- The Contractor should monitor concrete working tasks to ensure proper waste management techniques are being used. Monitor weather and wind direction to ensure that concrete dust is not entering drainage structures and waterways.
- Check structures daily for leaks (for example, holes in the liner) during concrete pours and repair the same day.
- Check the capacity of the washout structure. The structure(s) should be repaired, cleaned, or enlarged as necessary to maintain capacity for concrete waste.
- Structures should be cleaned out once they are two-thirds full to return the structure to a functional condition. Re-line the structure with new liner after each cleaning. If needed, new facilities should be constructed to provide additional concrete waste storage.
- Place a secure cover over the concrete washout facility prior to any predicted wet weather event to prevent accumulation and washout overflow. Inspect the structure as soon as possible following a storm and perform necessary maintenance.

27. Concrete Waste Management (CWM)



COLORADO
Department of Transportation

It is the responsibility of the contractor to follow these removal procedures:

- All liquid and solid wastes, including contaminated sediment and solids generated from concrete washout, should be hauled away from the site and disposed of properly. Do not incorporate hardened concrete waste from washout structures into the site because the conditions do not allow this concrete to cure sufficiently.
- Remove and dispose of materials used to construct the concrete washout structure.
- To prevent erosion, repair ground disturbance caused by the removal of the temporary concrete washout facilities. Backfill and cover the disturbed area with topsoil, seed, and mulch or other stabilized measure in a manner approved by the Engineer.

27. Concrete Waste Management (CWM)

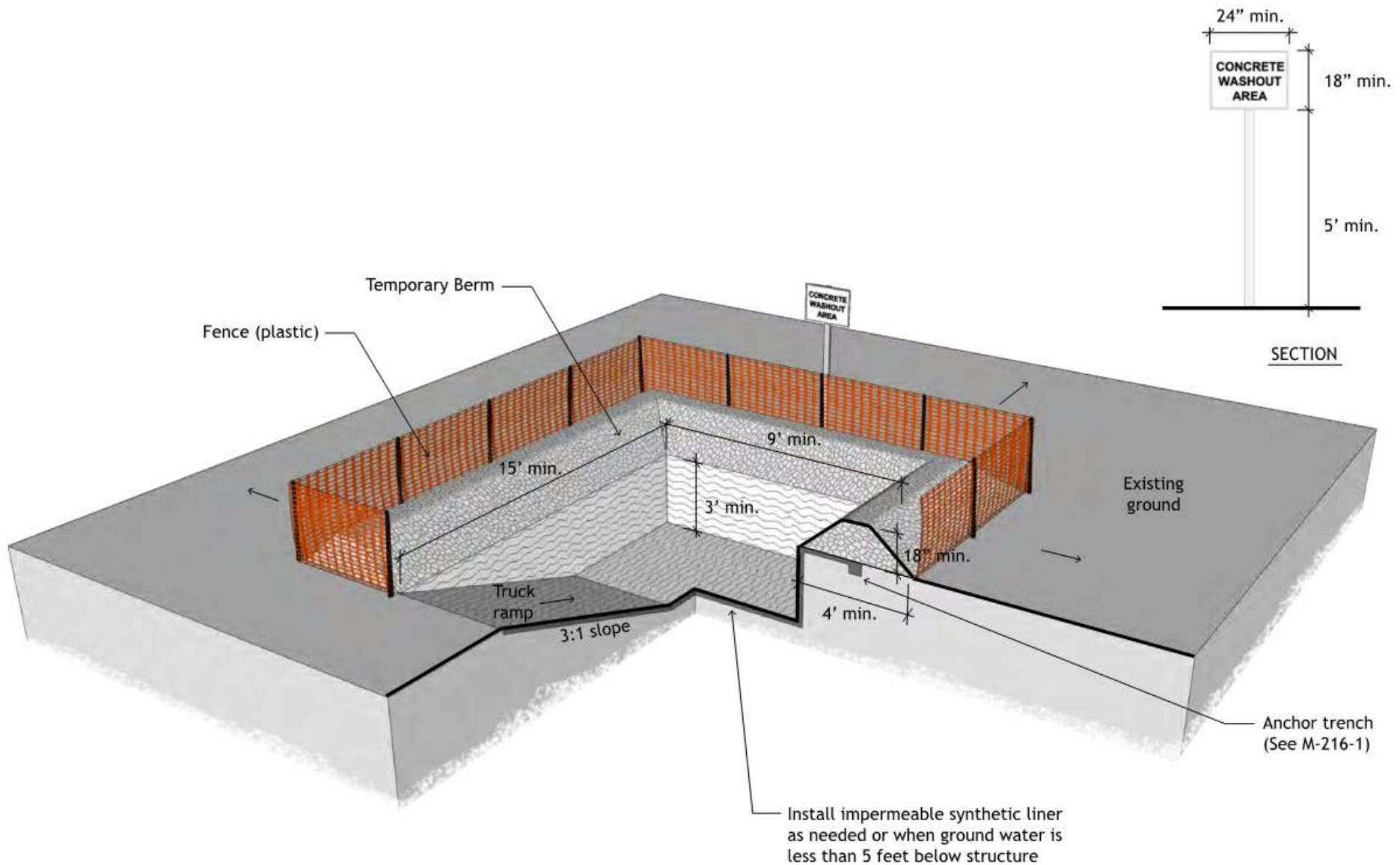

28. Materials and Waste Management (MWM)



This section will discuss control measures and management strategies for the following:

- A. Materials Management
- B. Liquid Waste Management
- C. Solid Waste Management
- D. Spill Prevention and Response procedures

CONTROL MEASURE USES

- Erosion Control
- Sediment Control
- Site/Materials Management



Site Waste and Materials Management

A. MATERIALS MANAGEMENT

1. DESCRIPTION

The purpose of Material Management is to prevent the material from being spilled or polluting stormwater and drainageways. Common practices include minimizing the storage of hazardous materials onsite, storing materials in a designated area, and installing secondary containment.

2. BASIS OF PAYMENT:

Section not applicable for this Management Strategy.

3. RELEVANT SPECIFICATION SECTIONS

[Section 208](#) - Erosion Control

- a) [208.02.\(e\)/\(f\)](#) - Materials

4. APPLICATIONS

Applied to all sites where delivery and storage of materials may be detrimental to the environment. Materials of concern include, but are not limited to:

- Pesticides, herbicides, and fertilizers
- Petroleum products
- Asphalt and concrete components
- Plaster
- Hazardous chemicals (acids, glues, lime, paints, solvents, adhesives, and curing compounds)
- Other materials that may be detrimental if released to the environment

5. LIMITATIONS

Space limitation may preclude indoor storage.

6. APPROVED MATERIALS

Section not applicable for this Management Strategy.

7. DESIGN AND INSTALLATION CRITERIA.

- Retain Safety Data Sheet for all materials stored and keep chemicals in their original containers.
- Use less hazardous, recycled, or nontoxic materials when possible.
- Use appropriately-sized secondary containment when storing hazardous materials.
- Use materials only where and when necessary to complete the construction activity.

28. Materials and Waste Management (MWM)



Recycle and properly dispose of leftover materials such as paintbrushes or paint containers.

- Dispose of used materials properly and never clean containers, such as paint containers, into a street, gutter, storm drain, or watercourse.
- Liquids listed in 40 Code of Federal Regulations 110, 117, or 302 should be stored in approved containers and drums without being overfilled and stored in temporary secondary containment facilities.
- Storage sheds must be leak free and meet building and fire code requirements in accordance with local jurisdiction.
- Herbicides should be applied by a licensed applicator and should not be overapplied.

8. PROCEDURES

Loading and Unloading Areas

- Cover loading and unloading areas to reduce exposure of materials to rainfall.
- Routinely check vehicles and equipment, such as valves, pumps, flanges, and connections for leaks.
- Direct offsite stormwater flows away by grading, berming, or curbing the area around the loading/unloading area.

Material Storage Areas and Practices

- Designate specific areas of the construction site for material delivery and storage. Place these areas near the construction entrance and away from drainage, discharge points, storm drains, and vehicular traffic. If possible, store hazardous or toxic materials in a covered area or indoors.
- Minimize onsite storage of material and schedule delivery of material for when it will be needed.
- A temporary containment facility should have a permanent cover and side wind protection or be covered during non-working days or prior to rain events.
- A temporary containment facility should not require maintenance for accumulated rainwater and spills. In the event of a spill, accumulated rainwater and spills should be collected and placed into drums and be handled as a hazardous waste unless testing determines the content to be nonhazardous.
- Separation between stored containers should be provided to allow for spill cleanup and emergency response access.
- Incompatible materials should not be stored in the same temporary containment facility.
- Do not remove original labels; maintain current legible labels with proper safety and disposal information.
- Store materials in a covered area during the wet season.
- Bagged and boxed materials should be stored on pallets and not allowed to accumulate on the ground surface. These materials should be covered during non-working days and prior to rain events.
- Provide cover or appropriate storage methods for Control Measures that may break down when exposed to the elements, such as straw material.
- Place hazardous chemicals, drums, or bagged materials onto pallets, under cover in secondary containment.
- Have proper storage instructions posted at all times in an open and known location.
- Keep containers tightly sealed after use.
- Keep ample supply of appropriate spill cleanup material near storage areas.

Material Delivery Practices

- Keep an accurate, up-to-date inventory of material delivered and stored onsite.
 - Trained employees in emergency spill cleanup procedures should be present when dangerous materials or liquid chemicals are unloaded.

28. Materials and Waste Management (MWM)



Spill Cleanup

- Contain and clean up any spill immediately.
- If significant residual materials remain on the ground after construction is complete, properly remove and dispose of any hazardous materials or contaminated soil.
- Refer to the Spill Prevention and Control Plan for spills of chemicals and hazardous materials.

9. MAINTENANCE AND REMOVAL

- Materials Management Maintenance and Removal
- Inspect material storage areas at least weekly and before, during, and after rainfall events. Collect and place any spills or accumulated rainwater into drums and dispose of properly.
- Storage areas should be kept clean and well-organized. Maintain an ample supply of cleanup materials at all designated storage and handling areas where leaks and spills are likely to occur.
- Spot-check material storage and handling areas for compliance. Ensure that storage containers are regularly inspected for leaks, corrosion, support or foundation failure, or other signs of deterioration.
- Inspect perimeter controls, containment structures, covers, and liners routinely and repair when signs of degradation are visible. Repair and replace as needed to maintain proper function.
- Inspect equipment and vehicles routinely for leaks.
- Report spills or leaks into the storm drain at or near CDOT work areas to the CDOT illicit discharge hotline.

B. LIQUID WASTE MANAGEMENT

1. DESCRIPTION

These procedures and practices are applicable to construction projects that generate nonhazardous liquid byproducts, residuals, or waste, and other non-stormwater liquid discharges not permitted by separate permits.

2. BASIS OF PAYMENT:

Section not applicable for this Management Strategy.

3. RELEVANT SPECIFICATION SECTIONS

No standard Specification exists for this Management Strategy.

4. APPLICATIONS

This control measure applies to construction activities that produce nonhazardous byproducts, residuals, and wastes. This includes, but is not limited to:

- Drilling slurries or drilling fluids
- Grease-free and oil-free wastewater and rinse water
- Dredgings
- Other non-stormwater liquid discharges not permitted by separate permits

5. LIMITATIONS

- Disposal of some liquid wastes may be subject to specific laws and regulations, or to requirements of other permits secured for the construction project.
- This fact sheet does not apply to dewatering operations, hazardous waste management vehicle washwater and rinse water from vehicle and equipment cleaning operations, or concrete slurry residual.
- This fact sheet does not apply to non-stormwater discharges permitted by any NPDES permit.

28. Materials and Waste Management (MWM)



6. APPROVED MATERIALS

- Approved Sorbents for Spill Response:
 - Excelsior from Erosion Logs has been approved as an sorbent material and is one of the materials listed in Section 300.915 (g)(1) of the National Contingency Plan. Material should be collected and disposed of after use and not left in situ.

7. DESIGN AND INSTALLATION CRITERIA.

- Secondary containment shall be capable of containing the combined volume of all the storage containers plus at least 10 percent freeboard. For secondary containment that is used and may result in accumulation of stormwater within the containment, a plan shall be implemented to properly manage and dispose of all accumulated stormwater that is deemed to be contaminated (for example, has an unusual odor or sheen)

8. PROCEDURES

- The Contractor should hold regular meetings to ensure proper liquid waste measures are being adhered to and efforts are being made to minimize the amount of liquid waste produced. The Contractor is responsible for adhering to all permit requirements and federal, state, and local regulations for properly disposing of liquid waste.
- Precautions should be taken to ensure that proper spill prevention measures are being implemented to avoid accidental spills. Refer to the Spill Response and Control Plan for more information regarding spill response procedures.

Containing Liquid Waste

- Containers comprising liquids should be properly labeled, have secondary containment, and be stored away from drainageways, inlets, receiving waters, areas of high traffic, and areas of susceptible flooding.
- Drilling residue and drilling fluids shall not be allowed to flow into drainageways, inlets, receiving waters, or into the CDOT highway right-of-way.
- Liquid wastes generated as part of an operational procedure, such as water-laden dredged material and drilling mud, shall be contained and not allowed to flow into drainage channels or receiving waters prior to treatment.
- Contain liquid wastes in a controlled area such as a holding pit, sediment basin, rolloff bin, or portable tank.
- Containment devices must be structurally sound and leak free and have sufficient quantity or volume to completely contain the liquid wastes generated.
- Do not locate containment areas or devices where accidental release of the contained liquid can threaten health or safety, or discharge to water bodies, channels, or storm drains.

Capturing Liquid Wastes

- All liquid waste should be contained in designated areas, such as sediment basins, holding pits, or portable tanks. Designated areas should be located away from drainageways, inlets, receiving waters, areas of high traffic, and areas susceptible to flooding. Containment devices should be structurally sound, leak free, and of sufficient quantity or volume to completely contain the liquid waste generated.
- Do not allow liquid wastes to flow or discharge uncontrolled. Use temporary dikes or berms to intercept flows and direct them to a containment area or device for capture.
- If the liquid waste is sediment laden, use a Sediment Trap control measure for capturing and treating the liquid waste stream, or capture in a containment device and allow sediment to settle.

Disposing of Liquid Wastes

- Typical method is to dewater the contained liquid waste, using procedures such as described in the Dewatering Operations fact sheet (No. 31) and Sediment Basin control measure section of the CDOT Drainage Design Manual; dispose of resulting solids per Solid Waste Management strategies in this fact sheet.

28. Materials and Waste Management (MWM)



- Method of disposal for some liquid wastes may be prescribed in Water Quality Reports, NPDES permits, Environmental Impact Reports, 401 Water Quality Certifications or 404 permits, or local agency discharge permits and may be defined elsewhere in the special provisions.
- Liquid wastes, such as from dredged material, may require testing and certification to determine whether it is hazardous or not before a disposal method can be determined.
- Do not dispose of hazardous waste in dumpsters designated for construction debris.
- If necessary, further treat liquid wastes prior to disposal. Treatment may include, but are not limited to, sedimentation, filtration, and chemical neutralization

9. MAINTENANCE AND REMOVAL

- The Contractor should provide regular inspections and after each storm event to ensure proper liquid waste management measures are being followed. Findings must be properly documented and any deficiencies timely corrected.
- Remove deposited solids in containment areas and capturing devices as needed, and at the completion of the task. Dispose of any solids as described in the Solid Waste Management strategies section.
- Inspect containment areas and capturing devices frequently for damage, and repair as needed.

C. SOLID WASTE MANAGEMENT

1. DESCRIPTION

These procedures and practices are designed to minimize or eliminate the discharge of pollutants to the drainage system and water bodies as result of the creation, staging, or removal of construction site wastes.

2. BASIS OF PAYMENT:

Section not applicable for this Management Strategy.

3. RELEVANT SPECIFICATION SECTIONS

No standard Specification exists for this Management Strategy.

4. APPLICATIONS

Facilities or designated construction work areas where solid waste is generated. Solid waste can be classified as nonhazardous solid material including:

- Sanitary waste
- Rubber, plastic, and glass pieces
- Masonry products
- Food waste and general litter
- Cigarette packages and butts
- Unwanted or discarded construction and demolition products

5. LIMITATIONS

During the non-rainy season or in arid portions of the state, temporary stockpiling of nonhazardous solid waste may not require stringent drainage control measures. The Engineer for the project shall determine if drainage control measures are warranted for a specific construction site where nonhazardous solid waste is being stockpiled.

6. APPROVED MATERIALS

Section not applicable for this Management Strategy.

7. DESIGN AND INSTALLATION CRITERIA.

Section not applicable for this Management Strategy

28. Materials and Waste Management (MWM)



8. PROCEDURES

- Waste storage areas should be pre-approved by the Engineer.
- Storage areas for solid waste and waste collection areas should be located at least 50 feet from drainageways, watercourses, storm drains, and streets and should not be located in areas susceptible to frequent flooding. Solid waste storage and waste collection areas, such as dumpsters, are often best located near the construction entrance to minimize the traffic on disturbed soils.
- Control measures such as temporary berms or other temporary diversion structures should be used to prevent stormwater runoff from contacting stored solid waste at the project site.
- Consider secondary containment around waste collection areas to minimize the risk of stormwater pollution.
- Keep the site clean of litter and debris.
- Construction debris and litter from work areas within the construction limits should be collected and placed in covered trash receptacles. Priority should be given to remove waste and debris from drainage inlets, trash racks, and ditches to prevent clogging of the stormwater system.
- Litter should be collected on a weekly basis into watertight dumpsters. Closed dumpsters or other enclosed trash receptacles should be provided in various locations within the construction site boundaries.
- Dumpster washout at the construction site is prohibited.
- A trash hauling contractor should properly dispose of the collected waste in a timely manner. Notify trash hauling contractors that only watertight dumpsters are acceptable for onsite use.
- Solid waste shall be segregated properly into various categories for recycling or disposal. Proper disposal is required for each waste category. Segregate potentially hazardous waste from nonhazardous construction site debris, and segregate recyclable construction debris from other nonrecyclable materials.
- Additional disposal guidelines for hazardous materials and liquid waste are included in Spill Response and Control Plan and Liquid Waste Management practices, respectively. Make sure that toxic liquid wastes and chemicals are not disposed of in dumpsters designated for construction debris.
- Recycle materials whenever possible. The Contractor shall make every attempt to recycle useful vegetation, packaging material, and surplus construction materials when practical. Most construction materials can be recycled at recycling facilities.
- Construction and highway planting waste not stored in watertight dumpsters should be securely covered from wind and rain by covering the waste with tarps or plastic sheeting.
During Demolition
 - Plan for additional trash receptacles and more frequent pickup during the demolition phase of construction.

9. MAINTENANCE AND REMOVAL

- The Contractor should monitor onsite solid waste storage and disposal procedures as well as provide regular inspections and ensure proper solid waste management measures are being followed after each storm event.
- Clean up litter and debris from the construction site daily.
- Empty trash receptacles before they are full and overflowing.
- Remove litter from erosion and sediment control structures (for example, Silt Fence) frequently.

28. Materials and Waste Management (MWM)



D. SPILL PREVENTION AND RESPONSE

1. DESCRIPTION

Spill Prevention and Response procedures establish spill response and actions by anticipating when and how spills might occur on a specific project site and establishing defined actions to contain and clean up the spill. Spilled substances and any associated cleaning residue must be prevented from reaching receiving waters and/or entering the storm sewer system. Spills and leaks onsite must be cleaned up using dry methods whenever possible. If water or other liquid methods are used, then the washwater must be collected and disposed of properly.

2. BASIS OF PAYMENT

Section not applicable for this Management Strategy.

3. RELEVANT SPECIFICATION SECTIONS

[Section 208](#) - Erosion Control

- a) **208.06** - Materials Handling and Spill Prevention

[Section 107*](#) - Water Quality Control

- a) **107.25(b)6** - Construction Requirements

**Also, see [Revision of Section 107](#) - Water Quality Control*

4. APPLICATIONS

This management strategy applies to all construction activities. Spill prevention and control measures should be implemented when chemicals or hazardous substances are used, stored, or handled onsite. The Spill Response Plan should be completed prior to the Environmental Pre-construction Conference. Work shall not be started until the plan has been submitted to and approved by the Engineer.

- Sites and activities that are susceptible to spills include:
 - Transportation facilities
 - Loading and unloading areas
 - Fuel and chemical storage areas
 - Process activities
 - Dust- or particulate-generating processes
 - Waste disposal activities

5. LIMITATIONS

This section is not applicable for this management strategy.

6. APPROVED MATERIALS

- Approved Sorbents for Spill Response:
- Excelsior from Erosion Logs has been approved as a sorbent material and is one of the materials listed in section 300.915 (g)(1) of the National Contingency Plan. Material should be collected and disposed of after use and not left in situ..

7. DESIGN AND INSTALLATION CRITERIA.

- Identify materials delivered, handled, stored, and used at a project site.
- Identify project areas and activities potentially susceptible to spills and develop spill response procedures.
- Develop a Spill Response Plan in accordance with 208.06(c) based on the chemicals and materials located onsite.

8. PROCEDURES

- Educate employees and subcontractors on the potential hazards to humans and the environment from spills and leaks. Identify personnel responsible for implementing response and control procedures in the event of a spill.

28. Materials and Waste Management (MWM)



- Place a stockpile of spill cleanup materials where it can be easily and conveniently accessed.
 - Spills should be contained and cleaned up as soon as possible. If any leaks are identified, contain the source and properly clean up the spill immediately.
 - Use dry methods to clean up spills, never hose down or bury spill material. Residuals left over from the cleanup activity, such as absorbent pads or containers of spill material, should be disposed of properly.
 - If complete cleanup is not immediately possible, then spills should be fully covered and not exposed to rainfall.
 - Proper spill and illicit discharge reporting procedures should be followed for both hazardous and nonhazardous materials. Emergency procedures and appropriate contact numbers should be provided onsite and posted at storage locations.
 - Assess the area where a spill has occurred to verify that spill residuals are not present after initial cleaning and that the area does not need to be recleaned
- Spill Prevention, Control, and Countermeasure Plan (SPCC)
- A Spill Prevention, Control, and Countermeasure Plan (SPCC) is required if the site has aboveground bulk storage containers with a cumulative storage shell capacity greater than 1,320 U.S. gallons, or storage containers having a “reasonable expectation of an oil discharge” to State Waters. Oil of any type and in any form is covered, including, but not limited to, petroleum, fuel oil, sludge, oil refuse, and oil mixed with wastes other than dredged spoil. EPA Region 8 is responsible for administering and enforcing the SPCC plan requirements in Colorado. Prior to the start of work, the Contractor shall submit an SPCC Form that has been approved by EPA for the project.
- Cleanup and Storage Procedures
- It is the responsibility of the contractor to have all emergency phone numbers available at the construction site and to notify proper response agencies in a timely manner.
 - **Nonhazardous Materials (such as gasoline, paint, or oil)**
 - **Minor Spill:** The following measures should be implemented for nonhazardous materials that may be spilled in small quantities:
 - Contact the Spill Response Coordinators identified with the Spill Response Plan.
 - Personal safety is the primary importance.
 - Use absorbent materials to contain spills and clean the area of residuals.
 - All materials resulting from cleanup shall become the property of the Contractor and shall be removed from the site.
 - Do not hose down spill area with water.
 - **Significant Spill:** The following measures should be implemented for significant spills of nonhazardous materials:
 - Contact the Colorado Department of Public Health and Environment (CDPHE) 24-hour Environmental Emergency Spill Reporting Line (1-877-518-5608) within 24 hours of the spill event.
 - A written notification to CDPHE is necessary within 5 days.
 - Contact the **Colorado State Patrol 24-hour hotline** (303-239-4501) if the spill is on a state highway.
 - Report spill to Project Engineer and CDOT maintenance personnel on patrol.
 - Call the **CDOT illicit discharge hotline** (303-512- 4426) if spilled material spreads to CDOT storm drain or waterway adjacent to CDOT right-of-way.
 - Clean up spills immediately. Use absorbent materials if the spill is on an impermeable surface. Construct a slightly compacted earth dike to contain a spill on dirt areas. If rainfall is present at the time of the spill, cover the spill with a tarp to prevent contaminating runoff.

28. Materials and Waste Management (MWM)



o Hazardous Materials

- The following measures should be implemented for spills involving hazardous materials:
 - Personal safety is the primary importance.
 - o Stay upwind and at a safe distance/secure the area from anyone being harmed.
 - o Construction personnel shall not try to clean up the spill.
 - Contact the **local emergency response** team by dialing 911.
 - Contact Colorado Department of Public Health and Environment (CDPHE) 24-hour Environmental Emergency Spill Reporting Line (1-877-518-5608) within 24 hours of the spill event.
 - o A written notification to the CDPHE is necessary within 5 days.
 - Contact the **Colorado State Patrol 24-hour hotline** (303-239-4501) if the spill is on a state highway.
 - Report spills to the Project Engineer and/or CDOT maintenance personnel on patrol.
 - Call the **CDOT illicit discharge hotline** (303-512- 4426) if spilled material spreads to CDOT storm drain or waterway adjacent to CDOT right-of-way.
 - A licensed contractor or a HazMat team shall be used to properly clean up spills immediately.

9. MAINTENANCE AND REMOVAL

- Areas shall be inspected on a regular basis and after a storm event.
- Inspect equipment and vehicles routinely for leaks.
- Maintain an ample supply of cleanup materials at all designated maintenance areas where leaks and spill are likely to occur. Cleanup materials should be located near material storage, unloading and use areas.
 - o Spill Kits should contain materials appropriate for the work being done and the potential spill-related risks. This includes, but is not limited to, water-resistant nylon bag, oil-absorbent socks, oil-absorbent pads, nitrile gloves, and disposable bags with ties.
- When changes occur in the type of chemicals used or stored onsite, update spill prevention and control plans and stock appropriate cleanup materials.
- Spot-check material storage and handling areas for compliance.

29. Stockpile Management (SM)



1. DESCRIPTION:

Stockpile areas are used for temporary storage of construction materials and must be managed to minimize erosion and sediment transport from erodible material stockpiles.

2. CONTROL MEASURE USES

- Erosion Control
- Sediment Control
- Site/Materials Management

3. RELEVANT SPECIFICATION SECTIONS

[Section 208](#) - Erosion Control

- a) **208.07** - Stockpile Management

4. RELEVANT M-STANDARD DETAILS

No Standard Details exist for this Management Strategy.

5. BASIS OF PAYMENT

Pay item	Description	Pay Unit
208-00028	Plastic Sheeting	SY
213	Mulching	VARIES
208	Various items to contain perimeter	

6. APPLICATIONS

Areas where active and nonactive stockpiles of construction materials are stored.

7. LIMITATIONS

- Stockpiles should not be placed on paved areas unless no other practical alternative exists on-site.

8. APPROVED PRODUCTS LIST

Refer to: <https://www.codot.gov/business/apl>



Erosion Logs used for stockpile management practices

9. PROCEDURES

- Stockpiles should be placed a minimum of 50 feet away from State Waters and shall be confined so that no potential pollutants will enter State Waters and other sensitive areas. Stockpiles shall also be protected with a temporary perimeter control measure. Level-to-gently-sloping grassed areas provide good stockpile sites and should not be placed in or along wetlands, ditches, swales, or against slopes that are more than 2:1.
- Stockpiling of contaminated soils should be avoided. If unavoidable, these stockpiles should be covered with plastic sheeting with berms surrounding the stockpile to prevent runoff from leaving the construction site. Contaminated soils should be transported offsite.
- Implement wind erosion control practices in accordance with Wind Erosion Control (fact sheet No. 38) as appropriate on all stockpiles.
- Erodible stockpiles (including topsoil) must be contained with an acceptable control measure at the toe (within 5 to 10 feet of the toe) at all times

29. Stockpile Management (SM)



10. PROTECTION OF STOCKPILES FOR PROJECTS TEMPORARILY HALTED FOR 14 DAYS

- Soil Stockpiles:
 - Soil stockpiles should be covered or protected with interim stabilization in accordance with 208.04(e). If no longer needed, the stockpiles should be removed and disposed of properly.
- Stockpiles of aggregate base, or aggregate subbase:
 - These stockpiles should be covered or protected with a perimeter sediment barrier at all times. If no longer needed, the stockpiles should be removed and disposed of properly.
- Stockpiles of “cold mix”:
 - Cold mix stockpiles should be placed on and covered with plastic sheeting material at all times and surrounded by a berm.
- Stockpiles/storage of pressure treated wood with copper chromium and arsenic or ammonia, copper, zinc, and arsenate:
 - Treated wood should be covered with plastic sheeting material at all times and placed on pallets.
 - Along with plastic sheeting material, tarps can be used to cover unused materials and materials on pallets.

11. PROTECTION OF ACTIVE STOCKPILES

- Prior to the onset of precipitation, active stockpiles of the identified material should be protected further, as follows:
 - All stockpiles require temporary stabilization at the end of each day in accordance with 2018.04(e), and require a sediment barrier, such as Erosion Logs, Silt Fence, or Compacted Berms.
 - Stockpiles of cold mix should be placed on and covered with plastic sheeting material.

12. MAINTENANCE AND REMOVAL

- Routinely spot-check stockpile areas for compliance. Repair perimeter control and covers as needed. Sediment should be removed when sediment accumulation reaches half of the barrier height.
- Inspect containment structures or other perimeter controls routinely and repair when signs of degradation are visible.
- Remove stockpiles and dispose of properly if no longer needed.
- Re-vegetate or install other approved methods of final stabilization in areas where stockpiles and access roads are located.

30. Construction Road and Staging Area Stabilization (SA)



1. DESCRIPTION:

Construction Road and Staging Areas are clearly defined and stabilized areas where construction equipment, vehicles, stockpiles, and construction materials are moved through or stored.

2. CONTROL MEASURE USES

- Erosion Control
- Sediment Control
- Site/Materials Management

3. RELEVANT SPECIFICATION SECTIONS

[Section 304](#) - Aggregate Base Course

[Section 703](#) - Excavation and Embankment

a) [703.03](#) - Aggregate for Bases

4. RELEVANT M-STANDARD DETAILS

Section not applicable for this Management Strategy.



Stabilized Construction access road with secondary control measures

5. BASIS OF PAYMENT

Pay item	Description	Pay Unit
304-02000	Aggregate Base Course (class 1) Aggregate Base Course (class 2)	TON
304-09100	Aggregate Base Course (recycled asphalt pavement)	TON
208	Vehicle Tracking Pad	EACH
208	Vehicle Tracking Pad (pre-fabricated)	EACH

7. LIMITATIONS

- Designated areas may be impacted as a result of environmental constraints such as presence of wetlands or protected habitats.
- May require constant maintenance depending on the amount of vehicle traffic and type of materials being used for the construction project.
- Areas require soil preparation if area is to be restored to vegetative condition.

8. CONTROL MEASURE SOILS TRIANGLE

SOIL TEXTURE AND SUBGRADE CONDITIONS

- APPROPRIATE
- SOMEWHAT APPROPRIATE
- NOT APPROPRIATE

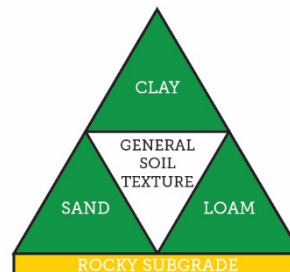

6. APPLICATIONS

- Used near construction site entrances or along designated areas to minimize and control impacts to the construction site.
- Used during wet weather periods to minimize tracking of mud and sediment.

30. Construction Road and Staging Area Stabilization (SA)



9. RECOMMENDED STANDARDS

- Locate Construction Road and Staging Areas in paved, predisturbed areas or where impacts to existing vegetation and habitat is minimized as much as possible.
- Construction Roads and Staging Areas must be installed prior to the beginning of construction activities.
- Where paved areas are not available for staging or construction roads, a layer of aggregate base course may be placed to provide vehicle stability.
- Clearly delineate construction roads and staging areas using perimeter control measures such as Silt Fence or Fencing (Plastic).
- Place Staging Areas near the main access points and, if possible, connected to Vehicle Tracking Control measures.
- Minimize the size of the Staging Areas and Construction Roads as much as feasible by coordinating with the Contractor to determine the storage needs and type of vehicles to be used during construction.

10. MAINTENANCE AND REMOVAL

- Topsoil must be salvaged and stockpiled prior to installing granular materials to construct access roads or staging areas.
- Granular base material must be clean of any amount of recycled concrete.
- Visually inspect to ensure Construction Roads and Staging Areas are adequately stabilized with aggregate base course or other materials as specified. Aggregate shall be re-applied or regraded as necessary if rutting occurs or underlying subgrade becomes exposed.
- After construction activities have been completed, aggregate base course material must be removed. This material may be cleaned, recycled, and reused or disposed of onsite at a designated location approved by the Engineer.
- In some cases, the aggregate base course may be contaminated and should be disposed of appropriately following the recommendations outlined in the Materials and Waste Management Section fact sheet (No. 28).
- All disturbed areas must be decompacted, stockpiled topsoil distributed, seeded, and mulched to re-establish native vegetation, or permanently stabilized by other means identified on the plans.

30. Construction Road and Staging Area Stabilization (SA)

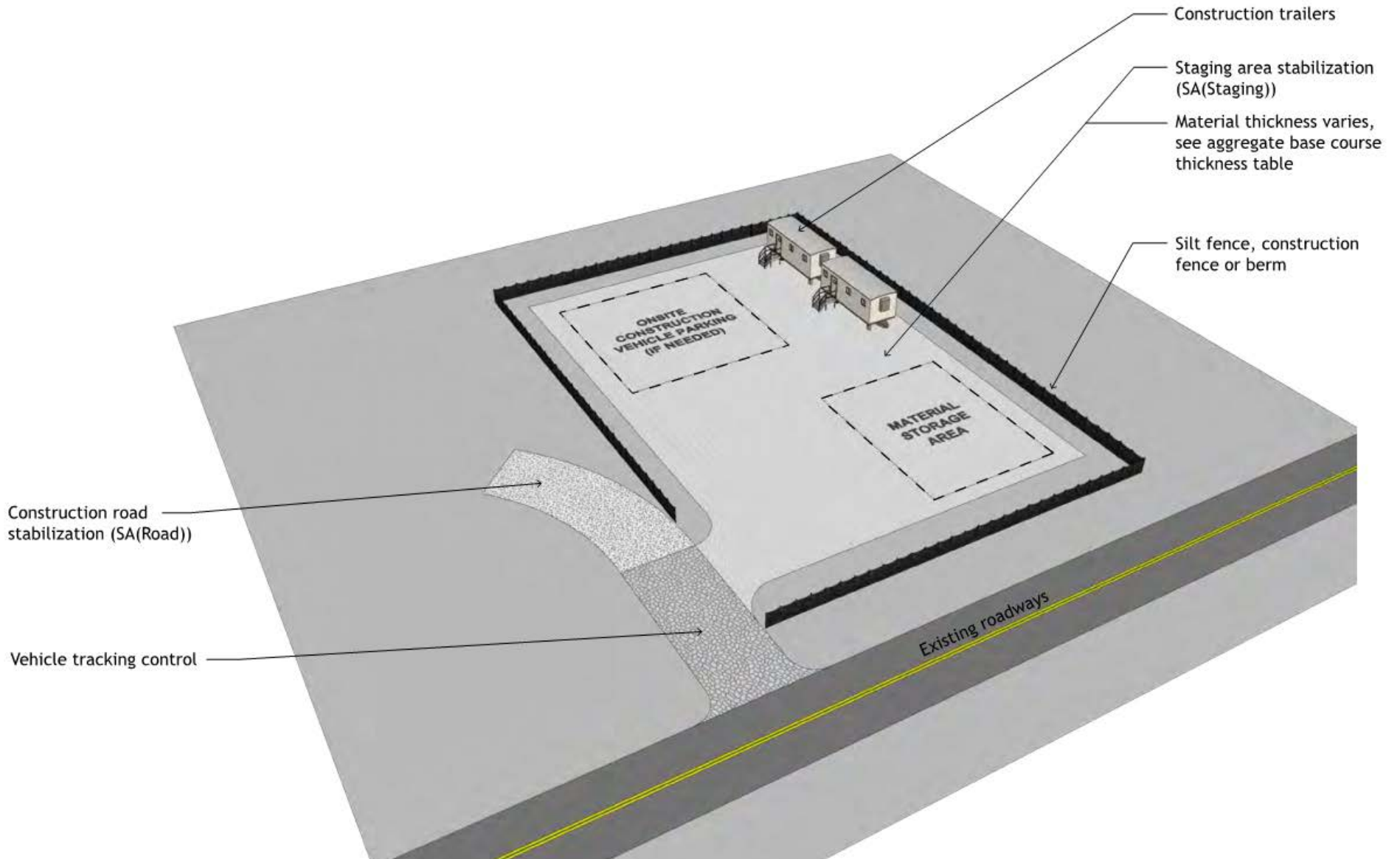

31. Dewatering Operations (DWO)



1. DESCRIPTION:

Dewatering Operations are point source discharges that use a series of Control Measures to remove groundwater and discharge it on surface water and/or over land. CDPHE Water Quality Control Division has several general permits available for dewatering construction groundwater. Uncontaminated groundwater can potentially be discharged to land under a construction stormwater discharge permit if all the criteria from the “*Low Risk Discharge Guidance of Uncontaminated Groundwater to Land*” (revised 8/8/17) are met. Dewatering stormwater not co-mingled with groundwater is also allowed through the construction stormwater discharge permit.



Use of Filter Bag during dewatering operations

2. CONTROL MEASURE USES

- Erosion Control
- Sediment Control
- Site/Materials Management

3. RELEVANT SPECIFICATION SECTIONS

No standard specification exists, project will require a Project Special Provision Specification.

4. RELEVANT M-STANDARD DETAILS

Section not applicable for this Management Strategy.

5. BASIS OF PAYMENT

Pay item	Description	Pay Unit
208-00041	Rock Check Dam	EACH

6. APPLICATIONS

- Used for the collection and discharge of surface water, stormwater, and nonhazardous groundwater within the construction site.
- Used when the construction site needs to be dewatered as the result of a storm event, groundwater presence, or existing ponding that would otherwise hinder construction activities.
- When used to remove sediment from construction dewatering activities, requires the strategic use of several Control Measures (e.g. Erosion Bales, Plastic Sheeting, and Sediment Traps).

7. LIMITATIONS

- Water from dewatering operations cannot be directly discharged into, wetlands, ditches, or existing storm sewer systems until treated by a series of control measures aimed to minimize the amount of sediment load.
- Water from dewatering operations cannot be discharged into state waters without a dewatering permit
- Preferred control measure means to be used will be determined by site conditions, construction, and permit requirements.

8. CONTROL MEASURE SOILS TRIANGLE

Section not applicable for this Management Strategy.

31. Dewatering Operations (DWO)



9. RECOMMENDED STANDARDS

- The Contractor must include Dewatering Operation Control Measures and method statements within the project SWMP for approval prior to the start of construction activities.
- Dewatering of non-stormwater might require the contractor to obtain a Construction Dewatering Permit from CDPHE.
- The Contractor is required to comply with all applicable local permits, project-specific permits, and regulations.
- Sediment removal from dewatering operations may be achieved by discharging water into a Sediment Trap following the recommended guidelines in fact sheet No. 18.
- Alternative means for sediment removal may include the use of retrofitted permanent water quality structures following the guidelines established in Temporary Use of Extended Detention Basins (fact sheet No. 24), Temporary Use of Sand Filter Structures (fact sheet No. 25) and Temporary Use of Filter Drains (fact sheet No. 26).
- When approved by the Engineer, Dewatering Filter Bags may be used to collect and remove sediment from dewatering operations given the following requirements are met:
 - Pollutant-laden water must be pumped directly into the Dewatering Filter Bag.
 - Dewatering Filter Bag must be placed on a level surface.
 - Level surface must be surrounded by Erosion Logs and lined with an impermeable geomembrane.
 - Treated water from Dewatering Filter Bag must be released in a stable, non-erosible surface such as vegetated overbank, riprap pad, or check structure.
 - Consideration should be given to groundwater dewatering operations, in particular when potential for the presence of contaminated water exists. This includes areas within 1 mile of a landfill, abandoned landfill, mine or mine tailing area, a Leaking Underground Storage Tank (LUST), brownfield site, or other area of contamination. Refer to the CDPHE Water Quality Control Division guidance and requirements for more information.

10. MAINTENANCE AND REMOVAL

- Conduct routine inspections for all construction sites to:
 - Identify adequate functioning or failure of installed Control Measures and need for maintenance.
 - Identify and evaluate if unwanted offsite discharge of pollutants has occurred.
 - Identify unwanted pollutant discharge points within and beyond the limits of the construction site to select removal and cleanup options.
- Periodic visual inspection of water treatment control measures is recommended; if discoloration, oil residues (with visible sheen), surface foaming or odor is noted.
- Contractor must obtain any concurrences and permits and provide copies of the documentation to the Engineer and Owner.
- All Dewatering Operations discharge must comply with regional and watershed-specific discharge requirements.
- Discharge of uncontaminated groundwater to land is acceptable given the following conditions are met:
 - Discharges are associated with short-term or intermittent Dewatering Operations and not expected to contain pollutants.
 - Discharges must meet the low risk discharge criteria as outlined in the August 8th, 2017 Low Risk Discharge Guidance.
 - No pollutants are present in the discharge, including chemicals, oil, grease, and corrosives.
 - No process discharges are present, including discharge from washing, heat exchange, or manufacturing.
 - The point and rate of discharge is controlled and known for all involved parties. Discharge rates must allow for runoff to infiltrate before entering State Waters or any drainage conveyance system.
 - Discharge contains no visible traces of petroleum products/waste.

31. Dewatering Operations (DWO)



COLORADO
Department of Transportation

- Secondary control measures are used to minimize sediment/solid content in the discharge prior to land application.
- Discharge use is located at a facility covered by a CDPS General Permit for Stormwater Discharge Associated with Construction Activities and identified on the SWMP
- Sediment accumulated from Dewatering Operations must be removed and disposed of appropriately in a landfill. If presence of other pollutants is suspected, applicable laws and regulations must be followed for disposal.

32. Paving Operations (PVO)



1. DESCRIPTION:

Paving Operations are control measure practices aimed at minimizing the transport and release of surface runoff pollutants into existing storm drain systems or State Waters, after coming in contact with sites of active roadway improvement activities.

2. CONTROL MEASURE USES

- Erosion Control
- Sediment Control
- Site/Materials Management

3. RELEVANT SPECIFICATION SECTIONS

[Section 208](#) - Erosion Control

- a) **208.04. (f)** - Control Measures for Stormwater, *Maintenance*

4. RELEVANT M-STANDARD DETAILS

Section not applicable for this Management Strategy.

5. BASIS OF PAYMENT

Section not applicable for this Management Strategy.

6. APPLICATIONS

- Used as means for general pollution prevention.
- Applicable to roadway paving, coring, joint construction, grooving and grinding, sealing, tacking, resurfacing, and saw cutting active construction areas.



Roadway asphalt paving operations

7. LIMITATIONS

- Only perform during dry weather conditions.
- Not applicable to roadway paving operations where:
 - Template of the roadway is changed.
 - Disturbance by the removal of pavement down to subbase or subgrade.

8. CONTROL MEASURE SOILS TRIANGLE

Section not applicable for this Management Strategy.

32. Paving Operations (PVO)



9. RECOMMENDED STANDARDS

- Existing storm drain capture systems must be protected at all times during paving operations. The use of Erosion Logs (fact sheet No. 17), Aggregate Bag (fact sheet No. 12), Storm Drain Inlet Protection (fact sheet No. 21) or other manufactured means for covering the storm inlets are acceptable practices.
- Asphalt trucks and spreading equipment must only use nonfoaming and nontoxic coating materials.
- When using thermoplastic striping techniques, pavement markers or performing pavement application or removal, equipment must be inspected for leaks. It is recommended to:
 - Avoid tank overfills by providing a 6-inch minimum freeboard.
 - Avoid material transfer within 50 feet of existing storm drain inlets or State Waters.
- When applying recessed pavement markers, transfer or load bituminous materials away from storm drain systems or State Waters. Avoid overfilling melting tanks to avoid splashing and release pressure from melting tanks before removing lids to fill or service.
- Drip pans and spill kits must be kept onsite to promptly control potential pollutant spread.
 - Materials to be used in Paving Operations must be stored away from drainageways or State Water.

10. INSTALLATION CRITERIA

- Visually inspect installed storm drain inlet control measures with regular frequency to ensure proper placement and unclogged conditions for optimal functioning.
- Do not attempt to wash paved surfaces. Sweep, shovel, and/or vacuum to remove loose materials following paving operations. It is recommended to follow procedures outlined in the Street Sweeping and Vacuuming fact sheet (No. 35).
- If hydrodemolition is used, wastewater generated from this activity must be collected and disposed of appropriately following local regulations. Do not allow this wastewater to enter the storm conveyance system.
- Ensure waste materials are removed from the site on a daily basis and do not remain on the roadway overnight.
- In case of spills, follow procedures outlined in the Materials and Waste Management Fact Sheet (No 28).
- Asphalt and pavement material must be recycled when possible. Follow current local and federal regulations for disposal of these materials when recycling is not feasible.

33. Protection of Existing Vegetation (PEV)



1. DESCRIPTION:

Protection of Existing Vegetation are control measure practices aimed to protect and preserve desirable existing vegetation during construction. These preservation practices provide increased erosion and sediment control by reducing the exposed and disturbed soil areas throughout the project construction.

2. CONTROL MEASURE USES

- Erosion Control
- Sediment Control
- Site/Materials Management

3. RELEVANT SPECIFICATION SECTIONS

[Section 208](#) - Erosion Control

- a) [208.03](#) - Materials
- b) [208.08.\(d\)\(1\)/\(17\)](#) - Documentation Available on the Project

[Section 607](#) - Fences

4. RELEVANT M-STANDARD DETAILS

Section not applicable for this Management Strategy.

5. BASIS OF PAYMENT

Pay item	Description	Pay Unit
607-11525	Fence (Plastic)	LF

6. APPLICATIONS

- May help reduce runoff volume, peak discharge rates, and erosion vulnerability of construction sites.
- May help prevent erosion, sediment, and pollutant release from areas used to convey concentrated flows.
- May reduce revegetation efforts in certain locations.
- May preserve vegetation in long-term project locations until the construction areas become active, thus temporarily reducing the need for control measures at these locations.



Rock check dam along lined drainage ditch

7. LIMITATIONS

- Vegetation can only be protected within project limits, and protective buffers must be identified, when feasible, by Contractor.
- Protecting existing vegetation may be expensive if it conflicts with grading or trenching operations. Cost versus benefit must be analyzed by Engineer, Owner, and regulatory agency.

8. CONTROL MEASURE SOILS TRIANGLE

Section not applicable for this Management Strategy.

33. Protection of Existing Vegetation (PEV)



9. RECOMMENDED STANDARDS

- Silt Fence or construction fencing may be used to delineate protection area.
- The concurrent use of construction fencing, and Silt Fence is not necessary unless a particularly sensitive resource is present that warrants the extra visibility that the orange construction fencing provides.
- Protection of identified vegetation or other resources must be clearly marked with high visibility paint or tape prior to the start of construction activities. These markings must be different from the ones used to mark trees for removal. Coordination with the Contractor will be necessary to ensure markings are clearly understood.
- Temporary soil berms made from the salvaged topsoil may also be used to delineate protection area. This approach will require a secondary barrier control measure such as Silt Fence or Erosion Logs.
 - This approach may be a good way to store topsoil onsite and minimize material hauling costs.
- If the potential for temporary impacts over sensitive resources (wetlands) is present, temporary wetland crossings for construction access may be constructed.
- Protection of existing vegetation and other resources is, most of the times, site-specific and consultation with a Wetland Biologist, Historian, Archeologist, and Paleontologist must occur if sensitive resources are involved .

10. MAINTENANCE AND REMOVAL

- Visually inspect perimeter control devices installed around the area of existing vegetation protection to ensure proper placement and breakage.
- Damaged perimeter control devices must be repaired or replaced immediately upon inspection to meet compliance with project commitments.
- If Silt Fence is used for perimeter control, sediment accumulation must be removed following the guidelines outlined in the Silt Fence fact sheet (No. 20).
- Following final stabilization of disturbed areas adjacent to protection areas, perimeter control devices may be removed and disposed of appropriately.
- Silt Fence and construction fencing may be disposed of in a landfill.

34. Scheduling and Coordination of Work (SCHEDULE)



1. DESCRIPTION:

Scheduling and Coordination of Work are practices used to help minimized the amount of potential erosion, sediment, and pollutant release by efficiently phasing construction to minimize site disturbance activities and by diligently inspecting and auditing compliance with the construction SWMP.

2. CONTROL MEASURE USES

- Erosion Control
- Sediment Control
- Site/Materials Management

3. RELEVANT SPECIFICATION SECTIONS

[Section 108](#) - Prosecution and Progress

- a) **108.03** - Project Schedule

[Section 208](#) - Erosion Control

- a) **208.03** - Project Review, Schedule, and Erosion Control Management
- b) **208.11**- Method of Measurement
- c) **208.12**- Method of Measurement

4. RELEVANT M-STANDARD DETAILS

Section not applicable for this Management Strategy.

5. BASIS OF PAYMENT

Pay item	Description	Pay Unit
208-00207	Erosion Control Management	DAY

6. APPLICATIONS

- Used to properly phase construction activities and determine the required control measures.
- Used throughout the project to ensure Owner and Contractor adhere to the stipulation of the construction permit and local regulations.
- Incorporated into Project Weekly Meetings and Inspection Reports.
- Incorporated in Preconstruction and Environmental Agendas.



On site work coordination

7. LIMITATIONS

- Site-specific environmental constraints, such as planting, runoff, and nesting seasons, may impact Schedule and Coordination of Work effort.
- Modifications made during construction need to be clearly communicated to Owner and Contractors.

8. CONTROL MEASURE SOILS TRIANGLE

Section not applicable for this Management Strategy

34. Scheduling and Coordination of Work (SCHEDULE)



9. RECOMMENDED STANDARDS

- Incorporate schedule and cut/fill phasing to the SWMP.
- When preparing the construction schedule, ensure exposed disturbed areas are minimized always. Schedule in such a way as to avoid disturbing the same area multiple times after they have received interim or permanent stabilization treatments.
- An adequate schedule will clearly define activities to be performed throughout all phases of construction including:
 - Preconstruction: Includes initial phasing, determination of appropriate perimeter control measures, mobilization, clearing and grubbing, wildlife impacts prevention and mitigation, and construction of any special control measure structures.
 - During Construction: Includes construction phasing, construction control measures installation, runoff control and diversions, earth-moving operations, and vehicle, materials, and waste management operations.
 - Post-construction and Stabilization: Includes cleanup, revegetation, and mitigation.
 - All phases: Include Transportation Erosion Control Supervisor and Regional Environmental Staff inspection schedule.
- Effective communication and coordination between the Transportation Erosion Control Supervisor, Regional Environmental Staff, third-party inspectors, Contractor, subcontractors and Project Engineer are crucial to stay on schedule and minimize site impacts.
- Scheduling and coordination of work must take into account public use and access to facilities in or near the construction site, traffic patterns and modifications required, and local weather.

10. OTHER CONSIDERATIONS

- When preparing a construction schedule, ensure consideration is given to local weather patterns, season seeding windows, and local public activities as these may have severe impacts to the schedule and create temporary shutdowns.
- Construction site inspection by the Erosion Control Supervisor or Regional Environmental Staff must occur at least every seven days and within 24 hours of any storm events.

35. Street Sweeping and Vacuuming (SSV)



1. DESCRIPTION:

When used as a temporary control measure, Street Sweeping and Vacuuming is intended to remove any sediment, mud, or debris that is tracked out onto paved public roads as a result of construction activities.

2. CONTROL MEASURE USES

- Erosion Control
- Sediment Control
- Site/Materials Management

3. RELEVANT SPECIFICATION SECTIONS

[Section 208](#) - Erosion Control

- a) **208.04. (f)** - Control Measures for Stormwater
- b) **208.12** - Basis of Payment

4. RELEVANT M-STANDARD DETAILS

Section not applicable for this Management Strategy.

5. BASIS OF PAYMENT

Pay item	Description	Pay Unit
208-00106	Sweeping (Sediment Removal)	HOUR

6. APPLICATIONS

- Used to collect and remove sediment tracked outside of construction areas, typically around entrance/exit locations.
- Used to prevent sediment transport to existing storm sewer systems downstream of construction locations.

7. LIMITATIONS

- Do not Sweep or Vacuum during wet weather conditions or when ground is wet. Must not be used as a perimeter control measure and only as a means to mitigate incidental sediment tracking.
- Street washing and sweeping with a kick broom is not allowed.



Sweeping and Vacuuming operations

8. CONTROL MEASURE SOILS TRIANGLE

Section not applicable for this Management Strategy.

9. RECOMMENDED STANDARDS

- Control the number of exit and entrance location to minimize potential for sediment tracking outside of the construction area.
- Pickup brooms, shovels, or other equipment capable of collecting sediment must be used for these activities.
- Kick brooms or sweeper attachments are not allowed for these activities.
- Using water to wash off tracked sediment (street washing) is not allowed under any circumstances.

35. Street Sweeping and Vacuuming (SSV)



10. MAINTENANCE AND REMOVAL

- Review permit requirements for street sweeping within the project's jurisdiction and ensure all permits are in place prior to the start of construction activities.
- Sweeping and Vacuuming operations may be required at the end of every working day when vehicles enter or leave the construction area.
- If heavy vehicle tracking occurs within the construction area, visible sediment should be removed immediately.
- Avoid sweeping unknown substances that may be hazardous. Refer to the Materials and Wastes Management fact sheet (No. 28) of this guide for more information.
- If significant tracking is observed constantly, ensure a Vehicle Tracking Control Measure is in place. If tracking continues, a tire wash station may be required. Refer to the Vehicle and Equipment Management fact sheet (No. 37) of this guide for more information.
- Debris-free sediment removed by sweeping and vacuuming operations may be dispersed onsite at locations designated by the Engineer. Otherwise sediment must be disposed of in a landfill.

36. Temporary Batch Plant, Onsite (TBP)



1. DESCRIPTION:

Check Dams (also referred to as a ditch check) are temporary control structures that can be constructed from rock, silt berms, or erosion logs. Check Dams can be installed across natural or constructed, and temporary or permanent, drainage ditches. They are intended to reduce the velocity of concentrated flows and reduce erosion potential within the ditch.

2. CONTROL MEASURE USES

- Erosion Control
- Sediment Control
- Site/Materials Management

3. RELEVANT SPECIFICATION SECTIONS

[Section 208](#) - Erosion Control

- a) *208.08 - Limits of Disturbance*
- b) *208.06 - Materials Handling and Spill Prevention*

[Section 107.25](#) - Water Quality

- a) *107.25(b) - Construction Requirements*

4. RELEVANT M-STANDARD DETAILS

Section not applicable for this Management Strategy.

5. BASIS OF PAYMENT

Not Measured and Paid for separately but shall be included in the work.

6. APPLICATIONS

- These guidelines apply to construction sites where temporary batch plant facilities are used. Some of the practices and guidelines described are also applicable to construction sites with general concrete use.



Concrete Batch Plant

7. LIMITATIONS

- Additional permitting, such as a General Industrial NPDES permit, CDPS-Stormwater Construction Permit, or Concrete Batching Plants - APEN and Application for Construction Permit, may be required for the operation of TBPs depending on their duration and location.

8. CONTROL MEASURE SOILS TRIANGLE

Section not applicable for this Management Strategy.

36. Temporary Batch Plant, Onsite (TBP)



9. RECOMMENDED STANDARDS

- **Planning**
 - Proper planning, design, and construction of TBPs and access roads should be implemented to minimize potential water quality, air pollution, and noise impacts associated with TBPs.
 - It is recommended to construct TBPs downwind of existing developments.
 - Location of the TBPs should be included in the project SWMP. Refer to Standard Specification Section 208.03 for more SWMP details. TBPs should be implemented, inspected, and maintained in accordance to this plan.
- **Layout and Design**
 - TBPs should be located away from watercourses, drainageways, and drain inlets, and located at least 300 feet from any recreational area, school, residence, or other structure not associated with the project.
 - Berms should be placed around the TBP equipment to facilitate proper containment and cleanup of releases. A perimeter control should be installed around the TBP.
 - Install run-on controls where feasible.
 - Divert stormwater and non-stormwater runoff from unpaved portions of the TBP to a containment pond or treatment tanks. Divert runoff from the paved or unpaved portion of the TBP into a sump and pipe to a lined washout area or dewatering tank.
 - A stabilized construction entrance and vehicle tracking control pad should be installed at the plant entrance.
All surfaces within the TBP should be paved or covered with aggregate base course.

10. PROCEDURES

- **Operational Procedures**
 - Washout of concrete trucks should be conducted in accordance with Concrete Waste Management. Do not dispose of concrete into drain inlets, drainageways, or watercourses.
 - Washing of equipment, tools, and vehicles to remove concrete should be conducted in accordance to Vehicle and Equipment Cleaning and Maintenance and Concrete Waste Management.
 - Maintain silo filters, and equip silos and bulk storage trailers with dust-tight service hatches to reduce air emission.
 - All conveyors should be covered unless the material being transferred results in no visible emissions.
 - There should be no visible emissions beyond the property line while the equipment is being operated.
- **Tracking Control**
 - Trucks should not track PCC from TBP onto the CDOT right-of-way or other public roads. Use appropriate control measures to prevent tracking sediment offsite.
 - Access roads and areas between stockpiles and conveyor hoppers should be stabilized, watered, treated with dust-palliative, or paved to control dust emissions.
- **Material Storage**
 - Apply procedures to minimize the discharge of materials to the storm drain system, drainageway, or watercourse.
 - Minimize dispersion of finer materials into the air during operations.
 - Stockpiles should be covered and enclosed with perimeter sediment barriers. Unless the stockpiled material results in no visible emission, uncovered stockpiles should be sprayed with water and/or dust suppressant chemicals as necessary to control dust emissions.
 - Store bagged and boxed materials on pallets and cover on non-working days or prior to a rain event.
 - Provide secondary containment for liquid materials.
 - Dispose of or recycle waste materials, such as demolished PCC, as frequently as possible to minimize the amount of waste stored onsite.
 - Immediately clean up spilled materials, such as cement and fly ash.

36. Temporary Batch Plant, Onsite (TBP)



COLORADO
Department of Transportation

- **Equipment Maintenance**
 - Equipment should be maintained to prevent leaks and spills.
 - Maintain adequate supplies of spill cleanup materials and train staff to respond to spills.

11. MAINTENANCE AND REMOVAL

- Verify that TBP and activity-based Control Measures are in place based on the SWMP prior to the commencement of construction activities. It is recommended that control measures be inspected weekly at a minimum, and prior to forecasted rain events, daily during extended rain events, and after the conclusion of rain events.
- Inspect control measures subject to non-stormwater discharge daily while non-stormwater discharges occur.
- Inspect the TBP for proper functioning of the Control Measures with attention to materials, waste storage area, and stabilized construction entrance/exit and roadway.
- Inspect components of TBP daily during TBP construction and operation.
- Inspect and repair equipment daily.
- Inspect secondary containment areas for breaches.
- **Removal**
 - Remove stockpiled material and equipment.
 - Regrade the site as needed.
 - Revegetate and stabilize the area.

37. Vehicle and Equipment Management (VEM)



1. DESCRIPTION:

Vehicle and Equipment Management practices are used to minimize the potential discharge of pollutants associated with construction activities along with reducing the spread of invasive species.

2. CONTROL MEASURE USES

- Erosion Control
- Sediment Control
- Site/Materials Management

3. RELEVANT SPECIFICATION SECTIONS

[Section 107](#) - Legal Relations and Responsibility to Public

- a) **107.25(b)** - Water Quality Control Construction Requirements

[Section 208](#) - Erosion Control

- a) **208.06(b)** - Materials Handling and Spill Prevention.

4. RELEVANT M-STANDARD DETAILS

Section not applicable for this Management Strategy.

5. BASIS OF PAYMENT

This Management Strategy will not be measured and paid for separately but shall be included in the work.

6. APPLICATIONS

- Applicable to any areas of construction where vehicles or construction equipment are used, fueled, cleaned, maintained, or stored during the construction contract period.

7. LIMITATIONS

- All personnel must be adequately trained in proper vehicle handling, cleaning, and storage practices.
- Constant supervision and inspections may be necessary to ensure compliance is achieved.



Equipment management and repair

8. CONTROL MEASURE SOILS TRIANGLE

Section not applicable for this Management Strategy.

9. RECOMMENDED STANDARDS

- All areas where fueling, cleaning, maintenance, and storage of vehicles and construction equipment occurs must be clearly designated with signs and in the SWMP documents prior to the start of construction activities.
- When practical, conduct vehicle fueling, cleaning, and maintenance offsite to avoid potential for pollutant release.
- Provide a perimeter control measure, such as Erosion Logs, around the designated area of fueling, equipment cleaning, and vehicle washing.
- Locate all equipment and vehicle cleaning stations away from storm inlets, waterways, and drainage facilities not intended for this use.
- It is preferable to locate cleaning stations in sump areas to facilitate collection of washwater or contaminants for treatment and disposal.

37. Vehicle and Equipment Management (VEM)



9. RECOMMENDED STANDARDS (CONTINUED)

- **Temporary Tire Wash Station:**
 - In areas where heavy traffic is expected, and where typical measures such as Vehicle Tracking Control Devices and Street Sweeping and Vacuuming do not completely mitigate sediment tracking onto public paved roads, a Tire Wash Station is necessary.
 - The use of temporary Tire Wash Stations must be approved by the Transportation Erosion Control Supervisor or Regional Environmental Staff prior to installation.
 - A supply of washwater and means to collect water are necessary.
 - Temporary Tire Wash Stations must be constructed on a level surface; provide a layer of aggregate material and a heavy grating wash rack.
 - Vehicles may be washed using handheld power-washing or proprietary equipment.
 - Provide a lined temporary drainage ditch to route washwater to a sediment control measure location. A Sediment Trap may be used to treat washwater.
 - When necessary, portable tire wash systems may be used. Manufacturers installation and operation specifications must be followed to ensure proper device functioning.
- **Temporary Fueling Station:**
 - When onsite fueling is necessary a designated Temporary Fueling Station must be provided.
 - Fueling station must be constructed on an impervious concrete pad surrounded by a barrier device such as an Aggregate Bag to minimize rainfall run-on and be protected by a roof.
 - A stormwater catchment device must be provided to route potentially contaminated stormwater to an Oil Control Device (oil-water separator) or a dead-end sump.
 - Release of captured stormwater from the fueling station (with exception to the roof) must be approved by the Transportation Erosion Control Supervisor or Regional Environmental Staff.

10. MAINTENANCE AND REMOVAL

- An equipment and vehicle management checklist may be useful to track compliance with established procedures.
- An ample supply of cleanup materials must be maintained at all designated maintenance areas where potential pollutant release is likely to occur.
- Inspect equipment and vehicles routinely for potential leaks.
- Avoid hosing down work stations or areas where vehicles are stored or maintained.
- Ensure all vehicles observed to be carrying mud or sediment use the Temporary Tire Wash Station prior to exiting the construction site.
- Remove accumulated sediment and rock from the Temporary Tire Wash Station to ensure proper functioning.
- Staging, storage, and cleaning areas must be cleared and cleaned following guidance listed in the Materials and Waste Management fact sheet (No. 28) when the areas are no longer used for construction activities.
- Staging, storage, and cleaning areas will require permanent stabilization when the areas are no longer used for construction activities.

38. Wind Erosion Control (WEC)



1. DESCRIPTION:

Wind Erosion Control Measures consist of applying water, approved dust palliatives, or installing temporary, interim, or permanent stabilization (see the fact sheets for Mulching (Agricultural Straw or Hay [No. 2] and Hydraulically Applied [No. 3]) materials to minimize dust nuisances and wind erosion caused during land disturbing construction activities.

2. CONTROL MEASURE USES

- Erosion Control
- Sediment Control
- Site/Materials Management

3. RELEVANT SPECIFICATION SECTIONS

[Section 208](#) - Erosion Control
[Section 209](#) - Water and Dust Palliatives
[Section 624](#) - Irrigation System: Appropriate Control Measure Section
[Section 213](#) - Mulching

4. RELEVANT M-STANDARD DETAILS

Section not applicable for this Management Strategy.

5. BASIS OF PAYMENT

Pay item	Description	Pay Unit
209-00600	Dust Palliative (Magnesium Chloride)	GALLON
213-00012	Bonded Fiber Matrix	ACRE
212-00151	Bonded Fiber Matrix	LB

6. APPLICATIONS

- Used as means for general pollution prevention in any construction site where wind erosion is expected.
- Used for stockpile management.
- Used during excavation and backfill operations at the end of the day, and to apply temporary stormwater and wind erosion protection.



Water truck used for dust suppression

7. LIMITATIONS

- Effectiveness may depend on soil type, temperature, humidity, and wind velocities.

8. CONTROL MEASURE SOILS TRIANGLE

Section not applicable for this Management Strategy.

9. RECOMMENDED STANDARDS

- Soil roughening, Mulching (Agricultural Straw or Hay), Bonded Fiber Matrix, Spray-on Mulch Blanket, Mulch Tackifier, Soil Retention Blankets, Seeding, Construction Road and Staging Area Stabilization, and Vehicle Tracking Control may be used as means to minimize wind erosion.
- Truck watering may be used until soil is moist and may be repeated as necessary given the following guidelines are met:
 - Avoid oversaturating soil and causing runoff from project site.
 - Non-potable water may be used in portable distribution systems. Tanks must be labeled "NON-POTABLE WATER - DO NOT DRINK."
 - Equipment must have a positive means of shutoff.
- In open areas, wind fences may be installed perpendicular to the prevailing wind direction to reduce wind speeds through the construction site.
- No chemical dust suppression products may be used as Wind Erosion Control Measures.

38. Wind Erosion Control (WEC)



COLORADO
Department of Transportation

10. MAINTENANCE AND REMOVAL

- Visually inspect treated areas for signs of erosion caused by soil oversaturation. If erosion is encountered, stop irrigation practices until the area is stabilized.
- When water is used, visually inspect treated areas to detect signs of oversaturation. If oversaturation occurs, ensure a secondary control measure treatment is provided downstream to capture generated runoff. [Erosion Logs] or [Silt Fence] may be used for this purpose.
- Water-based Wind Erosion Control may require constant application depending on the weather and wind force.

Acronym and Abbreviations



COLORADO
Department of Transportation

%	Percent
<	Less Than
>	Greater Than
AASHTO	American Association of State Highway and Transportation Officials
ABC	Aggregate Base Course
AD	Public Advertisement for Bid
APL	Approved Products List
CATEX	Categorical Exclusions
CBC	Concrete Box Culvert
CD	Check Dams
CDOT	Colorado Department of Transportation
CDPHE	Colorado Department of Public Health and Environment
CDPS-SCP	Colorado Discharge Permit System-Stormwater Construction Permit - Also known as SCP
CFS	Cubic foot per second
CL	Centerline
CMP	Corrugated Metal Pipe
CWA	Clean Water Act (1972)
CY	Cubic Yard
DSR	Design Scoping Review
EA	Environmental Assessment
EB	Eastbound
ECM	Erosion Control Management
EIS	Environmental Impact Statement
EPA	Environmental Protection Agency
FDR	Full Depth Reclamation
FES	Flared End Section
FHWA	Federal Highway Administration
FIR	Field Inspection Review
FL	Flow Line
FONSI	Finding of no Significant Impact
FOR	Final Office Review
FT/SEC	Foot (feet) per Second
FTW	Federal Transit Administration
HQ	Headquarters
LB	Pound
LB/FT	Pound(s) per Foot (feet)
LB/FT ²	Pound(s) per Square Foot (feet)
LDA	Limits of Disturbance Area
LF	Linear Foot
LS	Lump Sum
LT	Left
MS4	Municipal Separate Storm Sewer System
NEPA	National Environmental Policy Act
NPDES	National Pollutant Discharge Elimination System

Acronym and Abbreviations



COLORADO
Department of Transportation

PCC	Portland Concrete Cement
PF	Plastic Fence/Construction Fence (indicate limits of disturbance and for restricting access for the protection of wetlands, veg, historic, etc.)
PLS	Pure Live Seed
RCP	Reinforced Concrete Pipe
RE	Resident Engineer
ROW	Right of Way
RPEM	Region Planning and Environmental Manager
RR	Riprap
RT	Right
RWPCM	Region Water Pollution Control Manager
SAQ	Summary of Approximate Quantities
SCP	Stormwater Construction Permit
SH	State Highway
SPCC	Spill Prevention, Control, and Countermeasure Plan
SRB	Soil Retention Blanket
STA	Station
SWMP	Stormwater Management Plan
SWMP - ADMIN FOR DESIGN	Swmp Administrator for Design (must hold SWMP preparer cert)
SY	Square Yard
T&E	Threatened and Endangered Species
TBP	Temporary Batch Plant
TECS	Transportation Erosion Control Supervisor Certification
TRM	Turf Reinforcement Mat
UDFCD	Urban Drainage and Flood Control District
USACE	United States Army Corps of Engineers
VTP	Vehicle Tracking Pad
WB	Westbound
WQCV	Water Quality Capture Volume